

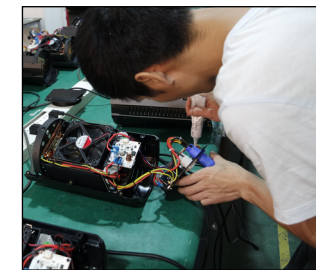

Factory



Motorized Production Line



Glue connectors



Aging Test



Temp & Humi Test Machine



Safety test

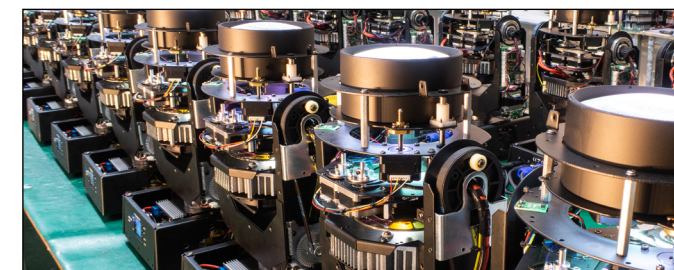

Mass production



QC Check

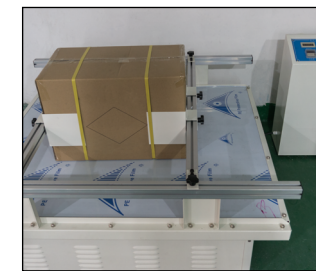

Transportation Test



Loading Container



REBORN 200

Source 4 LED retrofits



Reborn 200 is a LED retrofit for Source 4 profile. Upgrade your source 4 profile in just seconds. Features high CRI, bright output and low heat, energy save, clean and even light field, RDM function, long life LED, LCD display, XLR in & out, 100-240V worldwide voltage.

Key features:

- 175W LED light source, equivalent of 575W lamp
- Color temperature 3200K, 4000K, 5600K optional
- CRI≥98, R9≥93, TLCI 98 (3200K), CRI 90+ (4000K, 5600K)
- 3-pin XLR in & out signal connection(5-pin optional)
- Dimmer curves selectable
- Studio mode for super silent operation
- Wide voltage range 100-240V
- Dimmer frequency 1.2 - 20.0KHz
- Smooth dimming, video flicker free
- LCD display, user friendly interface
- Easy to setup, seconds to upgrade
- Intelligent temperature control, silent operation

Application:

- Broadcast, HD studio
- Theatre, church
- Fashion show
- Museum



Scan for video



Photometric

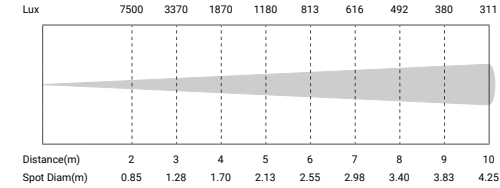

26° - 3200K

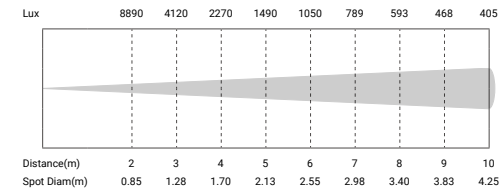

26° - 4000K

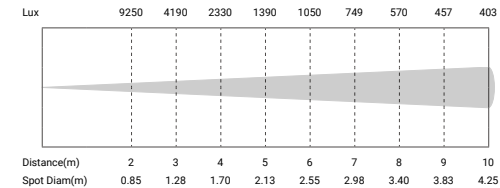

26° - 5600K

Color Rendition

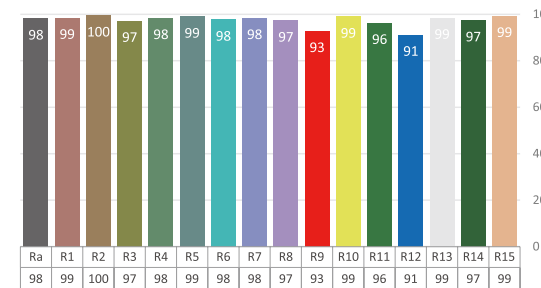

3200K

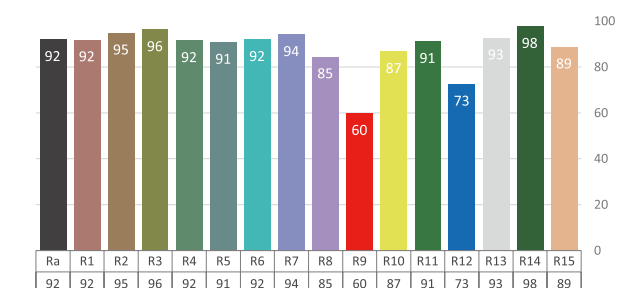

4,000K, 5600K

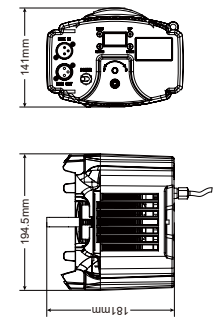

Technical Data

Power supply:	AC100 - 240V, 50/60Hz
Light source:	175W COB LED
Color temperature:	3200K, 4000K, 5600K optional
Color Rendition:	CRI 98, R9≥93, TLCI 98(3200K), CRI 90+ (4000K, 5600K)
Power connection:	Dedicated power in
Signal connection:	3-pin XLR in & out(5-pin optional)
Control channels:	1
Dimmer frequency:	1.2 KHz, 1.6 KHz, 2.4 KHz, 4.0 KHz, 6.0 KHz, 20.0 KHz
Dimmer curves:	Standard, Stage, TV, Architecture, Theatre, Studio(fan mode), Custom
Control mode:	DMX, RDM
Housing:	Color black, Die-cast aluminum
Size:	195 x 141 x186 mm
N.W.:	3 kg
Accessories(incl.):	Power cable, fix bolt
Environment:	IP20

THEATRICAL LIGHTING

THEATRICAL LIGHTING



Reborn 200T is a tunable white LED retrofit for Source 4 profile. Upgrade your source 4 profile in just seconds. Features high CRI, bright output and low heat, energy save, clean and even light field, RDM function, long life LED, LCD display, XLR in & out, 100-240V worldwide voltage.

Key features:

- 200W tunable LED
- Source 4 LED retrofits tunable white
- Color temperature 2200K-7000K adjustable
- 3-pin XLR in & out signal connection(5 pin optional)
- Dimmer curves selectable
- Studio mode for super silent operation
- Wide voltage range 100-240V
- Dimmer frequency 1.20-24.00KHz adjustable
- Smooth dimming, video flicker free
- LCD display, user friendly interface
- Easy to setup, seconds to upgrade
- Intelligent temperature control, silent operation

Application:

- Broadcast, HD studio
- Theatre, church
- Fashion show
- Museum

REBORN 200T

Source 4 LED retrofits



Photometric

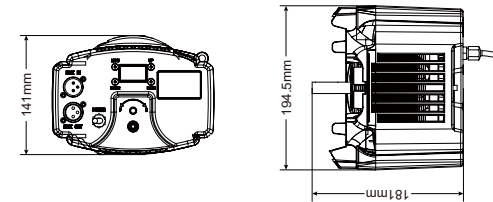
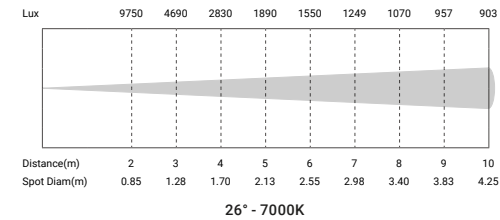
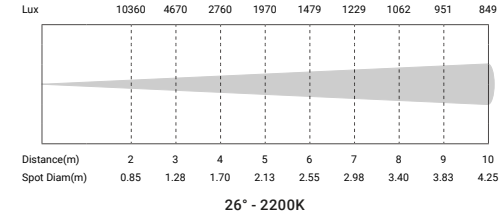

Technical Data

Power supply:	AC100-240V, 50/60Hz
Light source:	200W tunable LED
Color temperature:	2200K-7000K
Color Rendition:	CRI 94,TLCI 96
Power connection:	Dedicated power in
Signal connection:	3-pin XLR in & out(5-pin optional)
Control channels:	2/5
Dimmer frequency:	1.20-24.00KHz adjustable
Dimmer curves:	Standard, Stage, TV, Architecture, Theatre, Studio(fan mode), Custom
Control mode:	DMX, RDM
Housing:	Color black, Die-cast aluminum
Size:	195 x 141 x186 mm
N.W.:	3 kg
Accessories(incl.):	Power cable, fix bolt
Environment:	IP20

Color Rendition

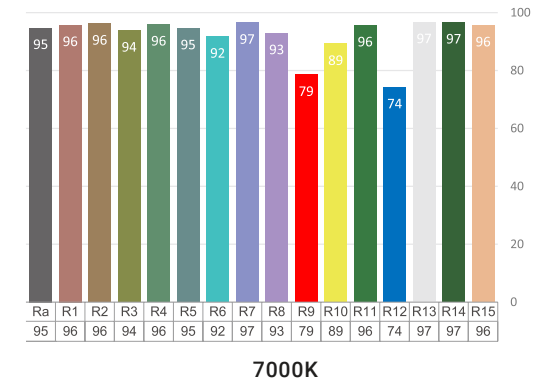
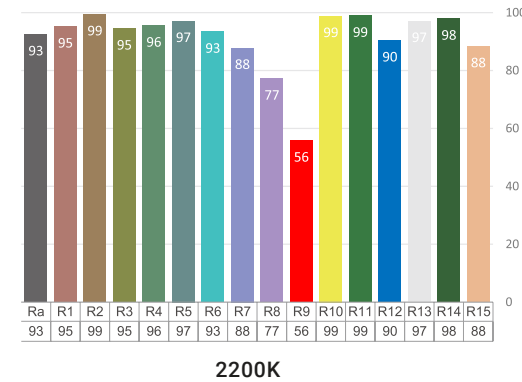

THEATRICAL LIGHTING

THEATRICAL LIGHTING



SOLAR PANEL 150T

150W tunable LED studio panel



Solar Panel 150T is a 150Watt tunable white LED studio panel light. It comes with even and wide wash effect, perfect control lighting area through eight leaf barndoor. Moreover, equipped with 150Watt warm white + 150Watt cool white high output LEDs, CRI 98, 98 TLCI brings perfect light quality. It is specially designed for TV studios, video shootings.

Key features:

- 150Watt ww+ 150Watt cw tunable white LED
- 3200K - 5600K tunable
- Super bright, uniform coverage
- Super silent operation for all circumstances
- High CRI 98, TLCI 98
- Turbo mode for high performance output
- Dimmer curves selectable
- Smooth dimming, flicker free operation
- Rotary control of dimmer and color temperature
- Dimmer frequency 1.2 - 20.0 KHz
- 8 - leaf barn door

Application:

- Broadcast, TV studio
- Film shooting
- Video shooting

Accessories:

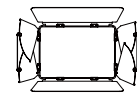

8 - leaf barn door

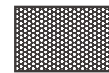

Beehive diffuser(opt.)

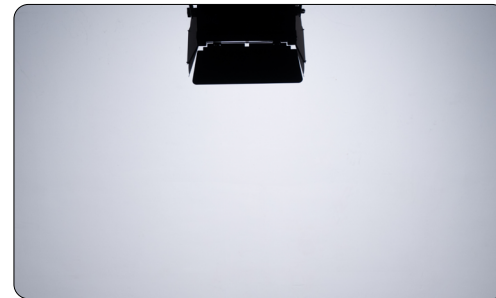

Photometric (Turbo mode)

WW - 3200K	4000	1000	540	330	230	160
CW - 5600K	4200	1150	580	360	240	200
Full on -4000K	4700	1300	660	410	280	180

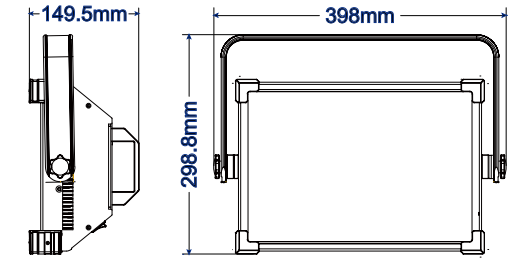
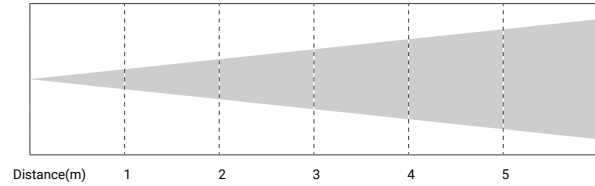

Color Rendition (5600K)

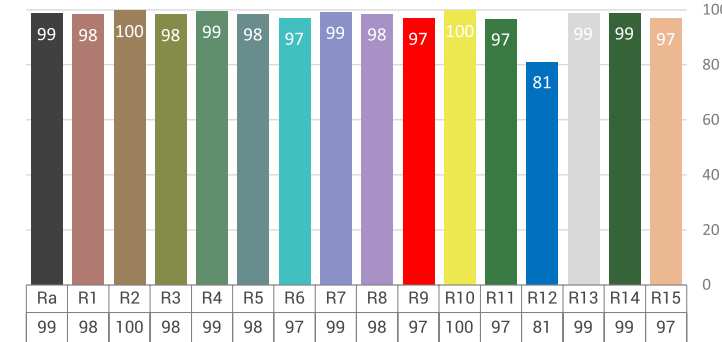

Spectral distribution- 5600K

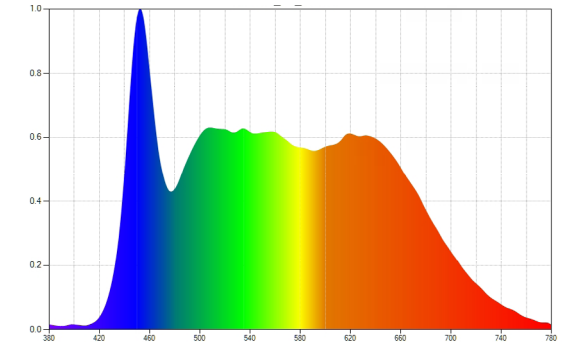

Technical Data

Power supply:	AC100 - 240V, 50/60Hz
Power consumption:	100Watt(standard mode), 150W max.(turbo mode)
Light source:	1440 x SMD LEDs
Beam angle:	120°
Color temperature:	3200K - 5600K
Color Rendition:	Avg. CRI 98, TLCI 98, TM-30 Rf 95, TM-30 Rg 101
Power connection:	PowerCON in & out
Signal connection:	3-pin XLR in & out

Control channels:	2/5
Control mode:	DMX, RDM, Rotary
Dimmer curves:	Standard / Stage / TV / Archi / Theatre/ Studio/ Turbo
Frequency:	1.2 KHz, 1.6 KHz, 2.4 KHz, 4 KHz, 6 KHz, 20 KHz
Housing:	Colour black, Aluminum
Size:	398 x 150 x 299 mm
N.W.:	5.5 kg(barn door incl.)
Accessories(incl.):	Power cable, Barn door, Safety cable
Environment:	IP20



SOLAR PANEL 300T

300W tunable LED studio panel



Solar Panel 300T is a 300Watt tunable white LED studio panel light. It comes with even and wide wash effect, perfect control lighting area through eight leaf barndoor. Moreover, equipped with 300Watt warm white + 300Watt cool white high output LEDs, CRI 98, 98 TLCI brings perfect light quality. It is specially designed for TV studios, video shootings.

Key features:

- 300Watt + 300Watt tunable white LED
- 3200K - 5600K tunable
- Super bright, uniform coverage
- Super silent operation for all circumstances
- High CRI 98, TLCI 98
- Turbo mode for high performance output
- Dimmer curves selectable
- Smooth dimming, flicker free operation
- Rotary control of dimmer and color temperature
- Dimmer frequency 1.2 - 20.0 KHz
- 8 - leaf barn door

Application:

- Broadcast, TV studio
- Film shooting
- Video shooting

Accessories:

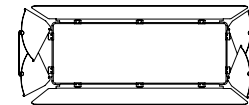

8 - leaf barndoor

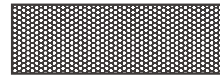

Beehive diffuser(opt.)



Photometric

WW - 3200K	8150	2420	1240	760	520	370
CW - 5600K	8670	2700	1330	830	550	410
Full on -4000K	8770	2600	1330	830	570	420

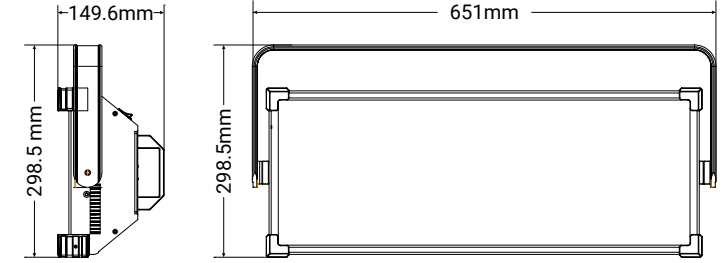
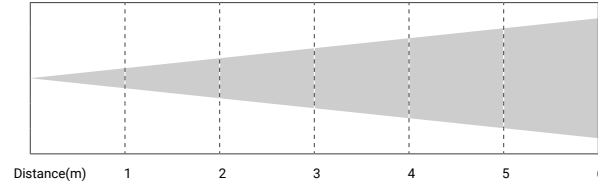

Color Rendition - 5600K

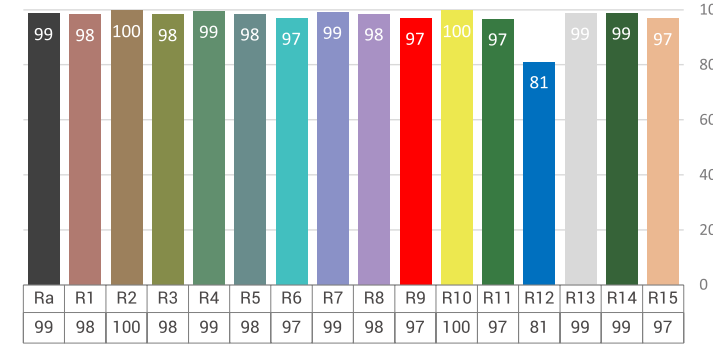

Spectral distribution - 5600K

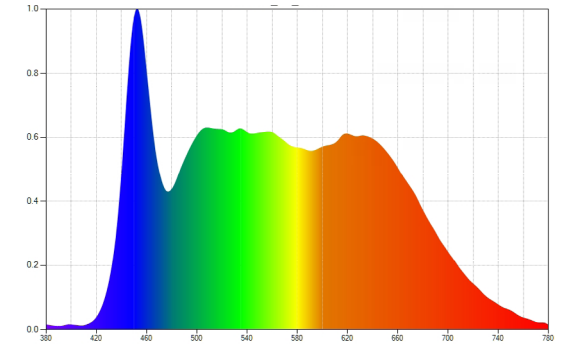

Technical Data

Power supply:	AC100 - 240V, 50/60Hz
Power consumption:	200Watt(standard), 300W max.(turbo mode)
Light source:	2880 x SMD LED
Beam angle:	120°
Color temperature:	3200K - 5600K
Color Rendition:	Avg. CRI 98, TLCI 98, TM-30 Rf 95, TM-30 Rg 101
Power connection:	PowerCON in & out
Signal connection:	3-pin XLR in & out
Control channels:	2/5

Control mode:	DMX, RDM, Rotary
Dimmer curves:	Standard / Stage / TV / Archi / Theatre/ Studio/ Turbo
Frequency:	1.2 KHz, 1.6 KHz, 2.4 KHz, 4 KHz, 6 KHz, 20 KHz
Housing:	Colour black, Aluminum
Size:	651 x 150 x 299mm
N.W.:	9.2 kg(barndoor incl.)
Accessories(incl.):	Power cable, barn door, Safety cable
Accessories(opt.):	Beehive diffuser, Clamp
Environment:	IP20

3200K/5600K
RDM
 Control
 Flicker Free
98
 TLCI
98
 CRI

Solar CYC is a cyclorama fixture with even and wide wash of wall, cyclorama or curtains. Equipped with solar spectrum LEDs, 98 CRI, 93 R9 and 98 TLCI, it is perfectly designed for TV studio, video shooting. First time in the industry, we bring healthy LED illumination concept into theatre and studio lighting field.

SOLAR CYC

WW / CW

LED cyclorama light



Key features:

- 175Watt white LEDs, 3200K/5600K optional
- Super bright, uniform coverage and even lighting
- CRI 98, R9≥93, TLCI 98
- Compatible with DMX and RDM protocols
- Dimmer curves selectable
- Flicker free operation
- LCD display
- Easy to setup
- PWM 1.2 - 20 KHz selectable

Application:

- Broadcast, HD studio
- Theatre
- Stage

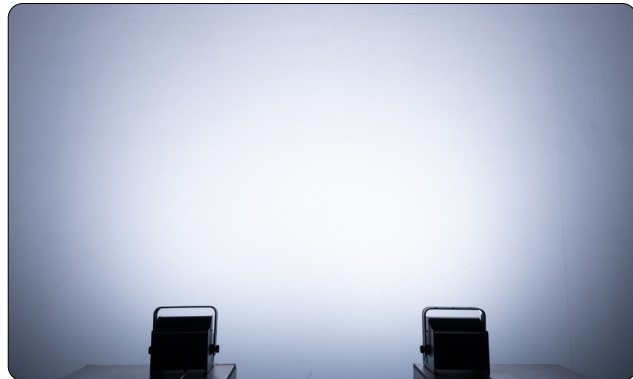

Color Rendition

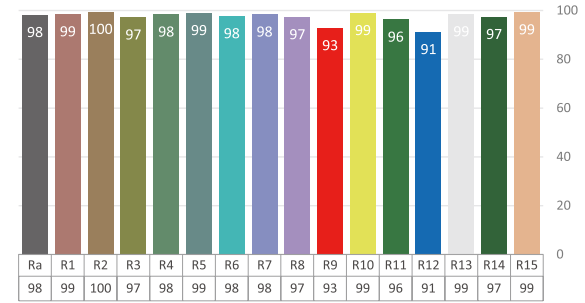

Spectral distribution - 3200K

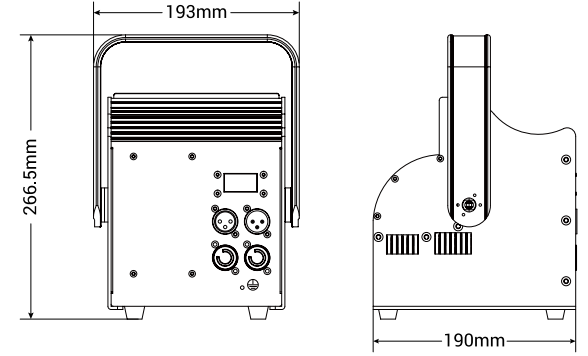
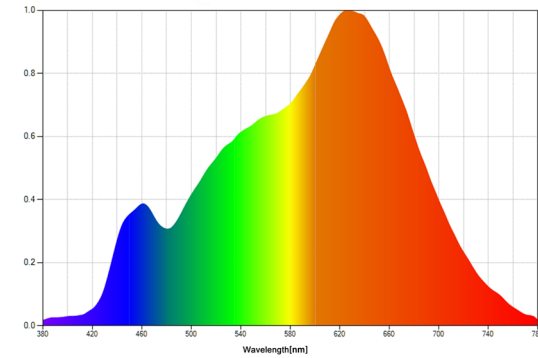

TM-30 3200K

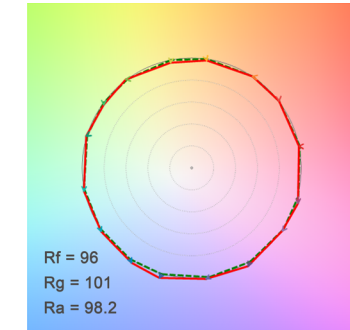

Technical Data

Power supply:	AC100 - 240V, 50/60Hz
Light source:	175W COB LED
Color temperature:	3200K or 5600K
Color Rendition:	CRI 98, R9≥93, TLCI 98
Power connection:	PowerCON in & out
Signal connection:	3-pin XLR in & out(5-pin optional)
Control channels:	1
Control mode:	DMX, RDM

Dimmer curves:	Standard/ Stage/ TV/ Architecture/ Theatre
Frequency:	1.2 KHz, 1.6 KHz, 2.4 KHz, 4 KHz, 6 KHz, 20 KHz
Housing:	Colour black, Aluminum
Size:	193 x 190 x 266.5mm
N.W.:	2.7 kg
Accessories(incl.):	Power cable
Accessories(opt.):	Safety cable, Clamp
Environment:	IP20



RDM

Control



CYC RGBW

LED RGBW cyclorama light

Equiped with high power RGBW LEDs, the CYC RGBW is a cyclorama fixture with even and wide wash of wall, cyclorama or curtains. Various built-in programs, small size body makes it easy to install and use.

Key features:

- 175Watt LEDs
- RGBW color mixing
- Super bright, uniform coverage and even lighting
- Compatible with DMX and RDM protocols
- Various preset programs
- Dimmer curves selectable
- Flicker free operation
- LCD display
- Easy to install and setup
- PWM 1.2 - 20 KHz selectable

Application:

- Theatre
- Stage

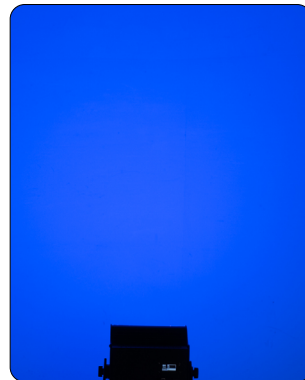

Technical Data

Power supply:	AC100 - 240V, 50/60Hz
Light source:	175W LED
LED color:	RGBW
Power connection:	PowerCON in & out
Signal connection:	3-pin XLR in & out(5-pin optional)
Control channels:	2/4/6/8
Control mode:	DMX, RDM
Dimmer curves:	Standard/ Stage/ TV/ Architecture/ Theatre
Frequency:	1.2 KHz, 1.6 KHz, 2.4 KHz, 4 KHz, 6 KHz, 20 KHz
Housing:	Colour black, Aluminum
Size:	193 x 190 x 266.5mm
N.W.:	2.7 kg
Accessories(incl.):	Power cable
Accessories(opt.):	Safety cable, Clamp
Environment:	IP20

Dimensions

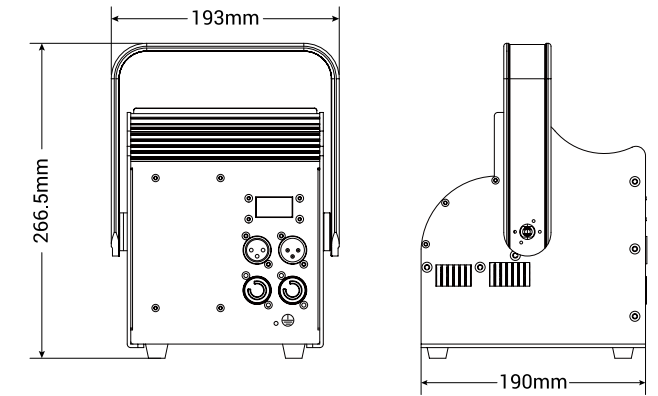



EVENT 100T

100W tunable LED fresnel zoom

The Event 100T is a 100Watt WW + 100Watt CW powered LED fresnel with zoom function. The RDM-DMX compliant, 25 - 65 degree manual zoom along with it's superior 95 CRI make this fixture a good replacement for the traditional fresnels.

Key features:

- 100Watt WW + 100W CW COB white LED
- 2700K - 6000K tunable color temperature
- Average CRI 95, TLCI 97
- Soft and even wash effect
- 25° - 65° manual zoom
- Smooth dimming, flicker free
- DMX, RDM control
- Dimmer curves selectable
- Silent operation for studio and theatre

Application:

- Broadcast, HD studio
- Theatre, church
- Film shooting
- Museum
- Exhibition lighting

Accessories:

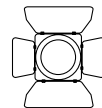

Barn door

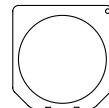

Gel frame



Photometric

WW(lx)	16700	5560	2230	1280	785
CW(lx)	23700	7530	2980	1750	1080
Full on(lx)	19000	6260	2530	1490	853

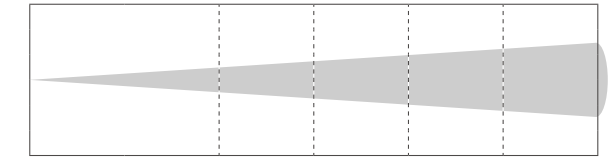

Distance(m)	1	2	3	4	5
Spot Diam(m)	0.55	1.11	1.66	2.22	2.77

Min. Spot - 25°

Color Rendition - 2700K

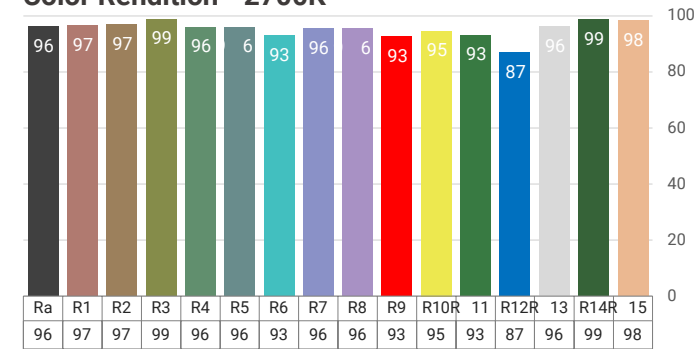

Technical Data

Power supply:	AC100-240V, 50/60Hz
Light source:	100Watt WW + 100W CW LED
Color temperature:	2700K - 6000K
Zoom range:	25° - 65° manual zoom
Color Rendition:	Average CRI 95, TLCI 97
Power connection:	PowerCON in & out
Signal connection:	3-pin XLR in & out
Control channels:	1/2/3/5
Control mode:	DMX and RDM

WW(lx)	4170	1390	547	318	214
CW(lx)	5670	1860	734	437	360
Full on(lx)	4680	1580	621	361	240

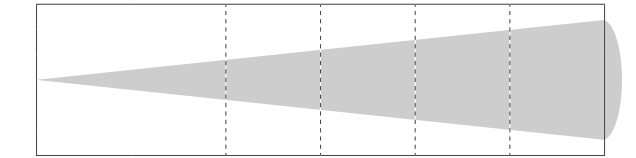

Distance(m)	1	2	3	4	5
Spot Diam(m)	1.7	3.4	5.1	6.8	8.5

Max. Spot - 65°

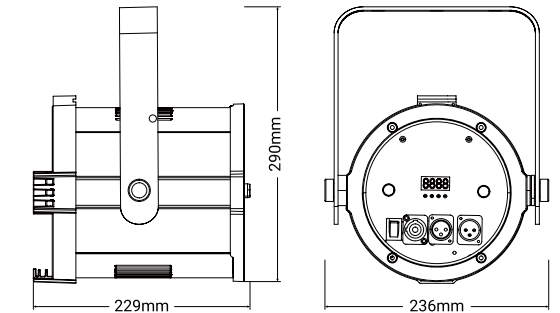

Dimmer speed:	4 grade
Housing:	Colour black, Aluminum
Size:	229 x 236 x 290mm
N.W.:	6.6 kg(barn door incl.)
G.W.:	4 kg
Accessories(incl.):	Power cable, barn door, gel frame, safety rope
Accessories(opt.):	Clamp
Compliance:	Pending
Environment:	IP20



EVENT 200T

200W tunable LED fresnel manual zoom

Event 200T is a 200Watt WW + 200Watt CW powered LED fresnel with zoom function. The RDM-DMX compliant, 25 - 65 degree manual zoom along with it's superior 95 CRI make this fixture a good replacement for the traditional fresnels.

Key features:

- 200Watt WW + 200W CW COB white LED
- 2700K - 6000K tunable color temperature
- Average R9≥95, TLCI 97
- Soft and even wash effect
- 25° - 65° manual zoom
- Smooth dimming, flicker free
- Knob, DMX and RDM controls
- Silent operation for studio and theatre

Application:

- Broadcast, HD studio
- Theatre, church
- Film shooting
- Museum
- Exhibition lighting

Accessories:

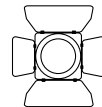

Barn door

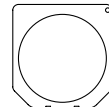

Gel frame

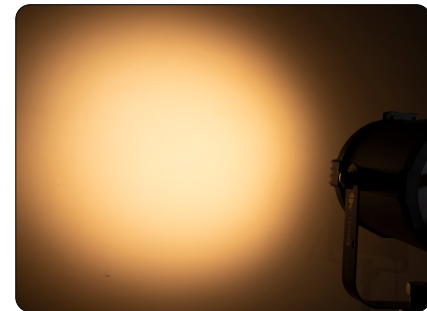

Photometric

WW(lx)	23300	6950	2650	1620	1120
CW(lx)	33200	10100	3880	2340	1560
Full on(lx)	19300	5910	2280	1380	938

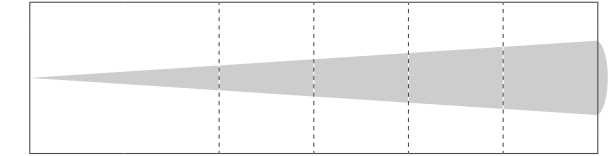

Distance(m)	1	2	3	4	5
Spot Diam(m)	0.55	1.11	1.66	2.22	2.77

Min. Spot - 25°

WW(lx)	5970	1930	747	457	373
CW(lx)	9150	2800	1070	648	558
Full on(lx)	4680	1580	621	361	240

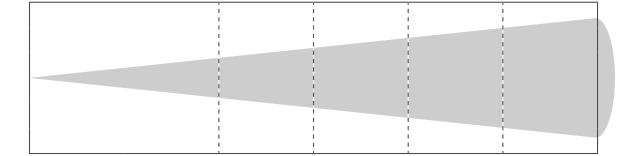

Distance(m)	1	2	3	4	5
Spot Diam(m)	1.7	3.4	5.1	6.8	8.5

Max. Spot - 65°

Color Rendition - 4000K



Technical Data

Power supply:	AC100-240V, 50/60Hz
Light source:	200Watt WW + 200W CW LED
Color temperature:	2700K - 6000K
Zoom range:	25° - 65° manual zoom
Power connection:	PowerCON in & out
Signal connection:	3-pin XLR in & out
Control channels:	1/2/3/5
Control mode:	Knob, DMX and RDM controls

Dimmer speed:	4 grade
Housing:	Colour black, Aluminum
Size:	300 x 200 x 195mm
N.W.:	3.6 kg(barn door incl.)
G.W.:	2.8kg
Accessories(incl.):	Power cable, barn door, gel frame, safety rope
Accessories(opt.):	Clamp
Environment:	IP20

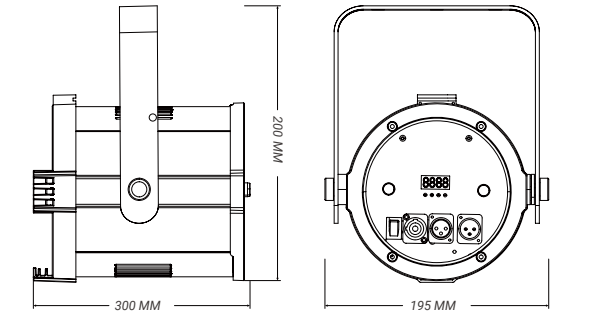



PANTO LEKO 60

60W tunable LED profile spot IP65

Panto Leko 60 is a 60W tunable COB LED profile spot. Die-casting housing, fan-free design. With 15° - 30° and 25° - 40° zoom lens optional, color temperature adjustable from 2700K - 6000K. It's an idea product for art gallery, museum, shopping mall.

Key features:

- 60W WW + 60W CW constant output LED
- 2700K - 6000K adjustable
- High CRI over 92
- Die-casting aluminum housing, fan-free
- HD optics, 15° - 30° and 25° - 40° zoom lens optional
- Smooth dimming, flicker free
- Compact body, easy to set up
- DMX control of dimmer, RDM support
- IP65, indoor or outdoor use
- Support E-sized gobo holder

Application:

- Museum
- Theatre, church
- Shopping mall
- Art gallery
- Restaurant

Accessories:

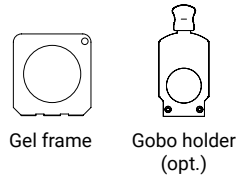

*Gobo size: E-sized, OD 37.5mm, image area 25.4mm



Photometric 15° - 30°

WW(lx)	9820	2370	1070	630	415
CW(lx)	9910	2890	1290	752	506
Full on (lx)	11500	2730	1240	715	480

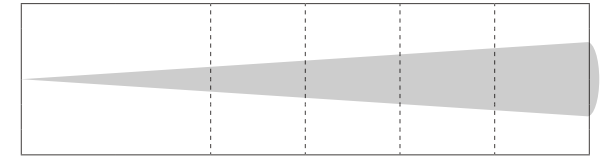

Distance(m)	1	2	3	4	5
Spot Diam(m)	0.26	0.67	1.00	1.34	1.67

Min. Spot - 15°

Photometric 25° - 40°

WW(lx)	7360	1440	623	341	224
CW(lx)	9920	1910	862	463	300
Full on (lx)	8550	1700	733	404	257

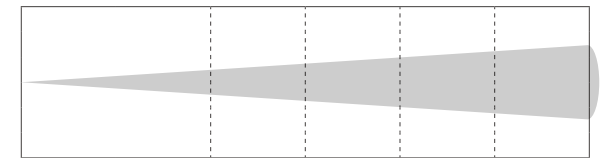

Distance(m)	1	2	3	4	5
Spot Diam(m)	0.44	0.89	1.33	1.77	2.22

Min. Spot - 25°

WW(lx)	5220	1210	543	314	205
CW(lx)	6444	1470	648	384	251
Full on (lx)	6130	1390	629	364	237

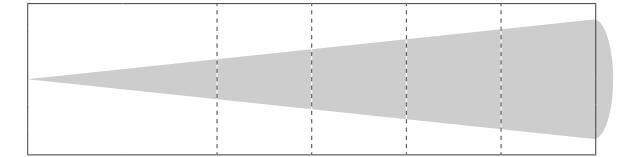

Distance(m)	1	2	3	4	5
Spot Diam(m)	0.54	1.11	1.66	2.21	2.77

Max. Spot - 30°

WW(lx)	2720	699	315	180	125
CW(lx)	3430	860	392	233	157
Full on (lx)	3210	8819	370	212	148

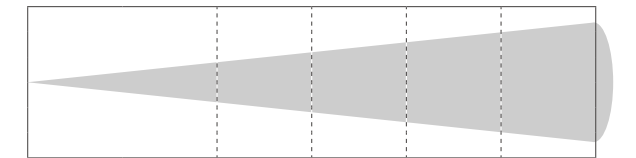

Distance(m)	1	2	3	4	5
Spot Diam(m)	0.73	1.45	2.18	2.90	3.63

Max. Spot - 40°

Technical Data

Power supply:	AC100 - 240V, 50/60Hz
Light source:	60W WW + 60W CW LED
Color temperature:	2700K - 6000K adjustable
Zoom range:	15° - 30°, 25° - 40° optional
Color Rendition:	Avg. CRI 92
Power connection:	IP rated power in
Signal connection:	3-pin XLR in & out
Control channels:	1/2/3/5

Control mode:	DMX, RDM
Housing:	Color black, die-casting aluminum
Size:	344 x 164 x 276mm
N.W.:	3 kg
G.W.:	4 kg
Accessories(incl.):	Power cable, Gel frame, Y split DMX cable
Accessories(opt.):	Gobo holder(E-sized), Clamp, Safety rope
Environment:	IP65



Panto Fresnel 60 is a 60W tunable COB LED fresnel. Die-casting housing, fan-free design. Color temperature adjustable from 2700K - 6000K. It's an idea product for art gallery, museum, shopping mall.

Key features:

- 60W WW + 60W CW constant output LED
- 2700K - 6000K adjustable
- High CRI over 92
- Die-casting aluminum housing, fan-free
- 90° wide range wash
- Smooth dimming, flicker free
- Compact body, easy to set up
- DMX control of dimmer
- RDM function available
- IP65, indoor or outdoor use

Application:

- Museum
- Theatre, church
- Shopping mall
- Art gallery
- Restaurant

Accessories:

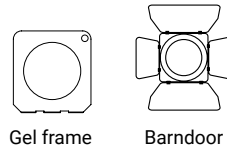

PANTO FRESNEL 60

60W tunable LED fresnel

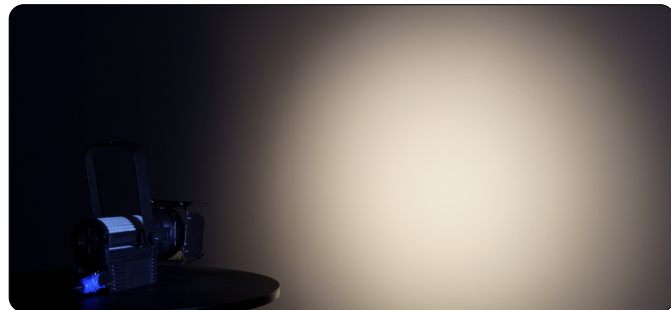

Photometric

WW (lx)	3730	860	385	220	148
CW (lx)	4260	1030	445	255	172
Full on (lx)	4210	1030	450	260	173

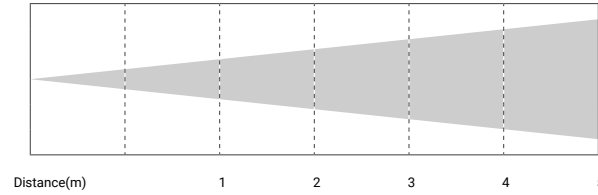

Color Rendition - 4000K

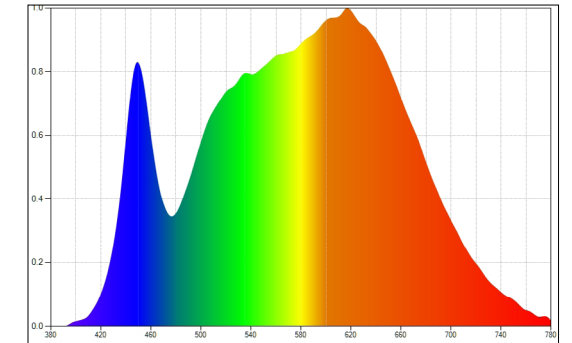
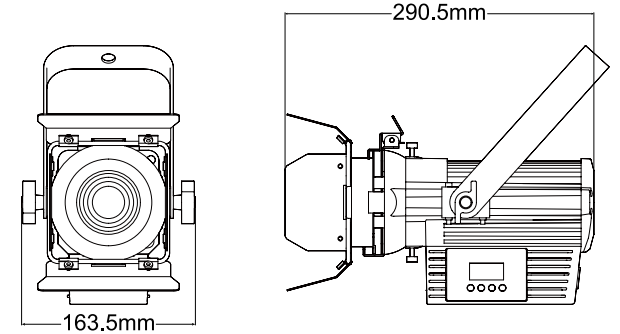
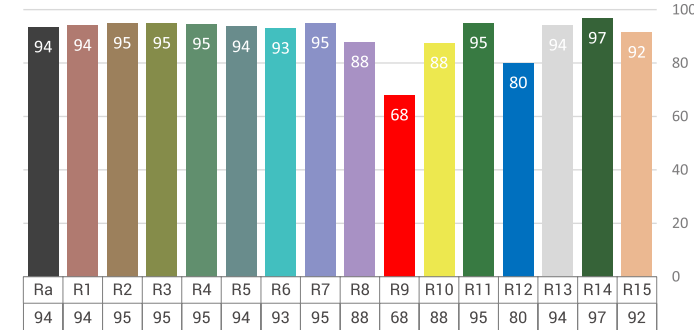

Technical Data

Power supply:	AC100 - 240V, 50/60Hz
Light source:	60W WW + 60W CW LED
Color temperature:	2700K - 6000K adjustable
Beam angle:	90°
Color Rendition:	Avg. CRI 92
Power connection:	Powercon True1 in
Signal connection:	3-pin XLR in & out
Control channels:	1/2/3/5

Control mode:	DMX, RDM
Housing:	Color black, die-casting aluminum
Size:	290 x 163 x 276mm
N.W.:	2.7 kg
G.W.:	3.5 kg
Accessories(incl.):	Power cable, Barndoor, Gel frame
Accessories(opt.):	Clamp, Safety rope
Environment:	IP65

THEATRICAL LIGHTING

THEATRICAL LIGHTING



Art 40 Spot is a 40W tunable COB LED profile spot. Aluminum housing, fan-free design. With 15° - 30° zoom lens, color temperature adjustable from 2700K - 6000K. It's an idea product for art gallery, museum, shopping mall.

Key features:

- 40W WW + 40W CW constant output LED
- 2700K - 6000K adjustable
- High CRI over 92
- Die-casting aluminum housing, fan-free
- HD optics, 15° - 30° zoom lens
- Smooth dimming, flicker free
- Compact body, easy to set up
- DMX control of dimmer, RDM support
- Available in black or white color

Application:

- Museum
- Theatre, church
- Shopping mall
- Art gallery
- Restaurant

Accessories:

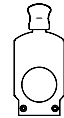

Gobo holder

*Gobo size: E-sized, OD 37.5mm, image area 25.4mm



ART 50 SPOT
40W tunable LED profile spot



Photometric 15° - 30°

WW(lx)	14300	4060	1490	833	536
CW(lx)	19200	5510	1950	1090	707
Full on (lx)	16000	4310	1630	925	595

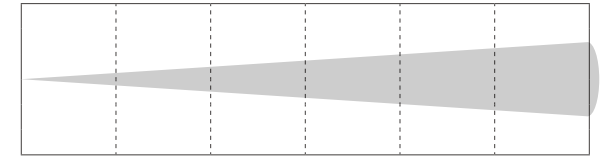

Distance(m)	1	2	3	4	5
Spot Diam(m)	0.32	0.63	0.95	1.25	1.58

WW(lx)	8040	1840	793	425	225
CW(lx)	11200	2720	1030	581	370
Full on (lx)	9200	2230	905	510	319

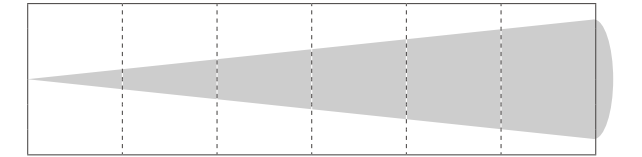

Distance(m)	1	2	3	4	5
Spot Diam(m)	0.43	0.86	1.25	1.72	2.15

Color rendition

Min. Spot - 15°

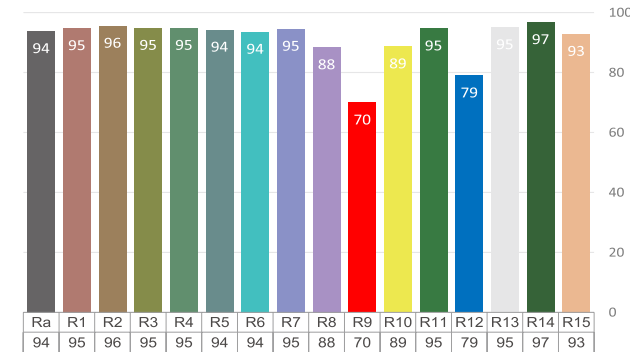

Max. Spot - 30°

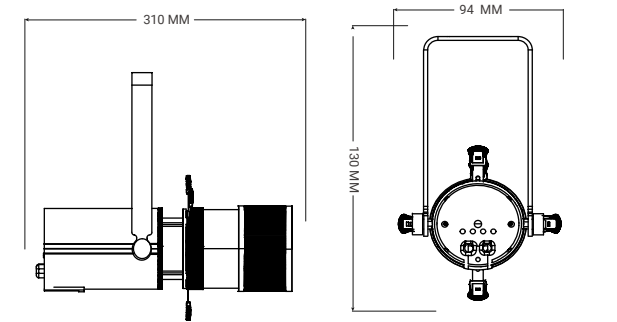

Technical Data

Power supply:	AC100 - 240V, 50/60Hz
Light source:	40W WW + 40W CW LED
Color temperature:	2700K - 6000K adjustable
Zoom range:	15° - 30° manual zoom
Color Rendition:	Avg. CRI 92
Power connection:	Dedicated power in
Signal connection:	3-pin XLR in & out
Control channels:	1/2/3/5

Control mode:	DMX, RDM
Housing:	Color black or white, aluminum
Size:	310x 130 x 94mm
N.W.:	1.2 kg
G.W.:	2 kg
Accessories(incl.):	Power cable, Y split DMX cable
Accessories(opt.):	Gobo holder(E-sized), Clamp, Safety rope
Environment:	IP20



UHD 60

60° UHD LED gallery light

UHD 60 is a 40W COB LED shapeable spot light, equipped with 60° UHD lens, color temperature 5600K. The customized lens fixed lens distortion issue in large de. It's an idea product for art gallery especially for locations where short distance illumination needed.

Key features:

- 40W CW COB white LED
- 5600K color temperature
- Four shutters to control the shape of light
- High CRI of 92
- 60° fixed lens
- UHD optics, no lens distortion
- Smooth dimming, flicker free
- DMX, RDM control
- Die-casting aluminum housing, fan-free
- Available in black and white body
- Track version optional

Application:

- Museum
- Art gallery
- Theatre, church
- Shopping mall
- Restaurant

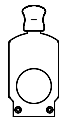

Gobo holder
E-sized

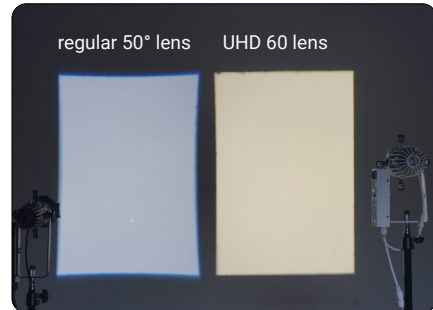

Photometric

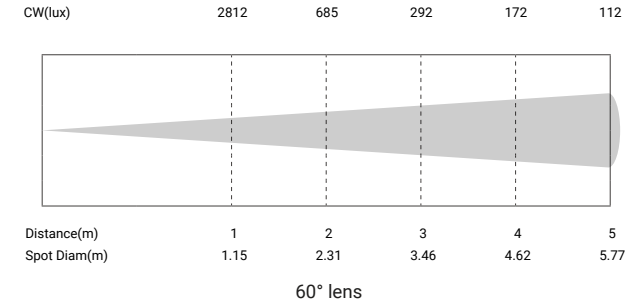

Color Rendition - 5600K

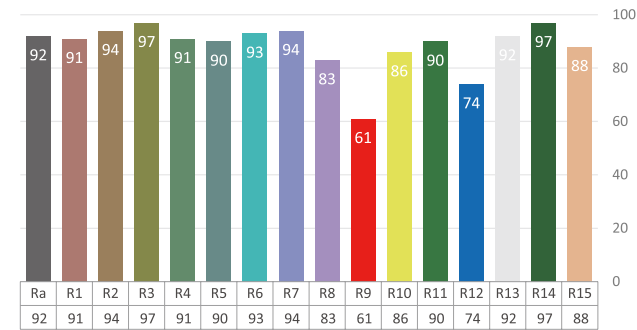

Technical Data

Power supply:	AC100-240V, 50/60Hz
Light source:	40W CW LED
Color temperature:	5600K
Color Rendition:	CRI 92
Fixed lens:	60° UHD fixed lens
Focus:	Manual focus
Power connection:	Dedicated power in
Signal connection:	3-pin XLR in & out
Control channels:	1
Control mode:	DMX and RDM
Housing:	Colour black or white, Aluminum
Size:	245 x 135 x 135mm
G.W.:	1.5 kg
Accessories(incl.):	Power cable, Gobo holder, Glass gobo(random)
Accessories(opt.):	Clamp
Gobo size:	E-sized, OD 37.5mm, image area 25.4mm, 1.4mm max thickness
Environment:	IP20

3200K/5600K
40W LED
Flicker Free
92 CRI

X40

WW / CW

40W LED profile single white

X40 is an upgraded version of mini profile 20, brightness increased by 50%. Die-casting housing, fan-free design. With 19°, 26°, 36°, 50° lens optional, track mount version selectable. It's an idea product for art gallery, museum, shopping mall.

Key features:

- 40W COB LED, high lumen
- 3200K or 5600K color temperature
- 50% brighter than Mini Profile 20
- High CRI of 92
- Die-casting aluminum housing, fan-free
- 19°, 26°, 36°, 50° lens selectable
- Smooth dimming, flicker free
- Compact body, easy to set up
- Track mount version selectable

Application:

- Museum
- Theatre, church
- Shopping mall
- Art gallery
- Restaurant

Accessories:

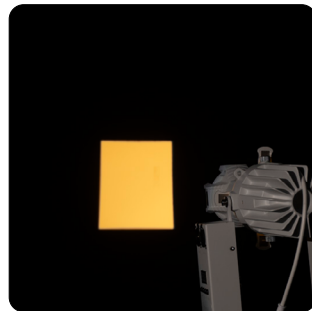
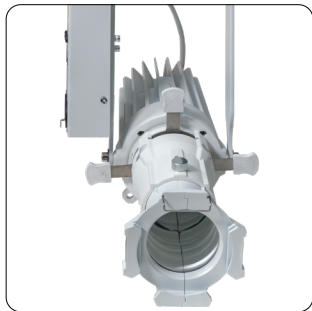
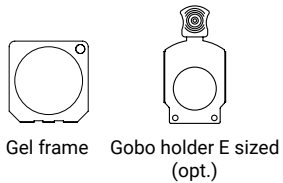

Photometric

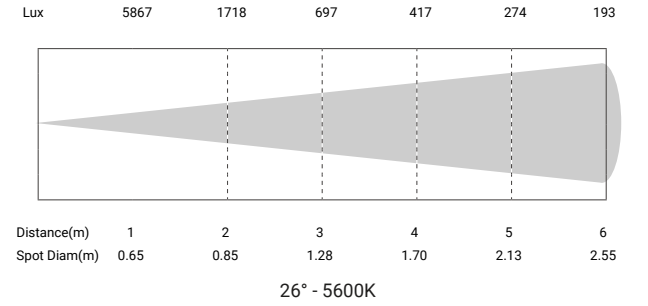
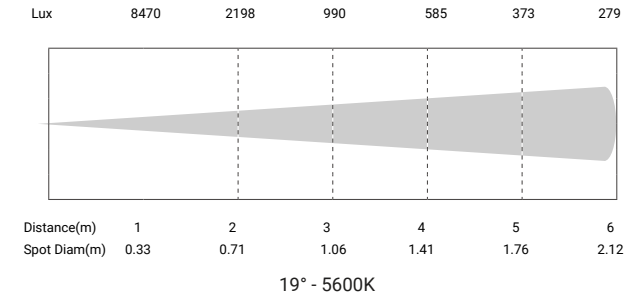

Color Rendition

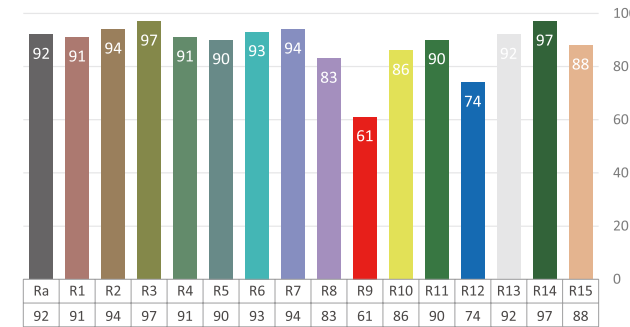

Technical Data

Power supply:	AC100 - 240V, 50/60Hz
Light source:	40W COB LED
Color temperature:	3200K or 5600K
Fixed lens:	19°, 26°, 36°, 50° optional
Color Rendition:	CRI 92
Power connection:	Dedicated power in
Signal connection:	3-pin XLR in & out
Control channels	1/3

Control mode:	DMX, track mount version optional
Housing:	Color black or white, die-casting aluminum
Size:	275 x 135 x 110mm
N.W.:	1.5 kg
Accessories(incl.):	Power cable, gel frame
Accessories(opt.):	Gobo holder E sized, Clamp, Safety rope
Environment:	IP20



X40T

WW / CW

X40T is an upgraded version of S20T, with brightness increased. Die-casting housing, fan-free design. With 19°, 26°, 36°, 50° lens optional, track mount version selectable. It's an idea product for art gallery, museum, shopping mall.

40W tunable LED profile spot

Key features:

- 40W WW+40W CW constant output LED
- 2700K - 6000K adjustable
- High CRI of 92
- Die-casting aluminum housing, fan-free
- 19°, 26°, 36°, 50° lens selectable
- Smooth dimming, flicker free
- Compact body, easy to set up
- DMX control of dimmer
- RDM function available

Application:

- Museum
- Theatre, church
- Shopping mall
- Art gallery
- Restaurant

Accessories:

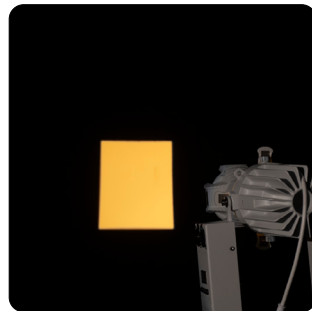
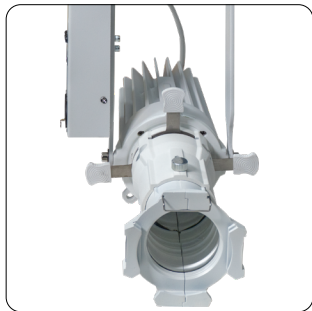
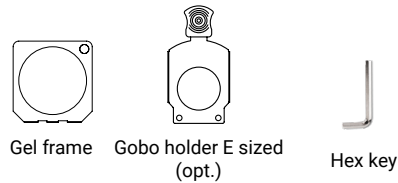

Color Rendition

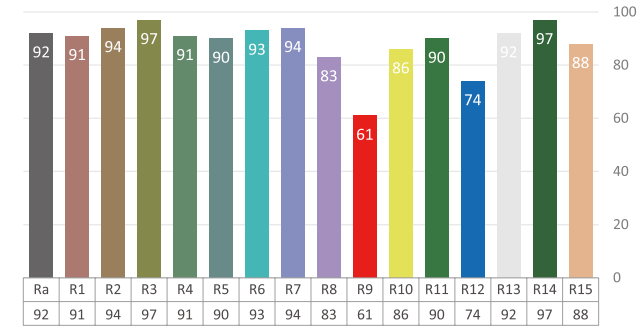

Technical Data

Power supply:	AC100 - 240V, 50/60Hz
Light source:	40W WW + 40W CW
Color temperature:	2700K - 6000K adjustable
Fixed lens:	19°, 26°, 36°, 50° optional
Color Rendition:	CRI 92
Power connection:	Dedicated power in
Signal connection:	3-pin XLR in & out
Control channels:	1/2/3/5
Control mode:	DMX, track mount version optional
Housing:	Color black or white, die-casting aluminum
Size:	275 x 135 x 110mm
N.W.:	1.5 kg
Accessories(incl.):	Power cable, gel frame
Accessories(opt.):	Gobo holder E sized, Clamp, Safety rope
Environment:	IP20



Mini Leko 20 is a tiny 20W COB LED profile spot. Die-casting housing, fan-free design. With 19°, 26°, 36°, 50° lens optional, and portable, track mount version selectable. It's an idea product for art gallery, Museum, Shopping mall.

MINI LEKO 20

WW / CW

20W LED profile spot

Key features:

- 20W COB LED, high lumen
- 3200K or 5600K color temp
- High CRI of 92
- Die-casting aluminum housing, fan-free
- 19°, 26°, 36°, 50° lens selectable
- Smooth dimming, flicker free
- Compact body, easy to set up
- Track mount version selectable
- Fresnel version selectable

Application:

- Museum
- Theatre, church
- Shopping mall
- Art gallery
- Restaurant

Accessories:

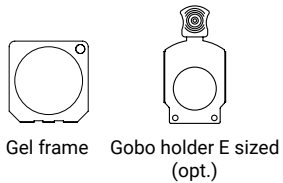

Gel frame Gobo holder E sized (opt.)



Fresnel version-Piospot 20



* Track mount version available*

Photometric

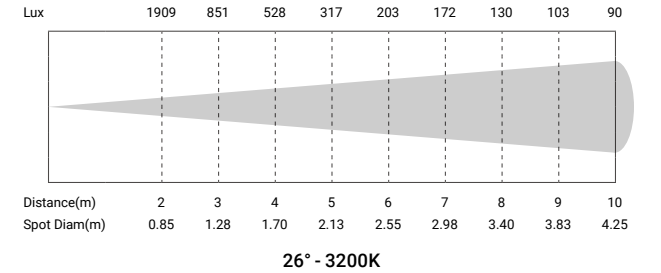
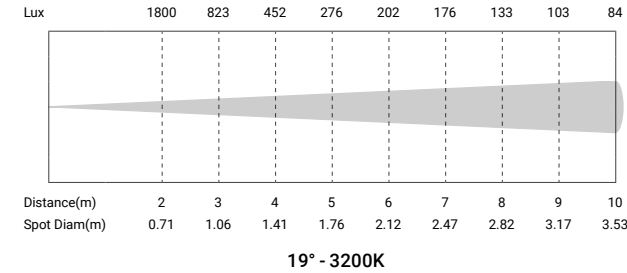

Color Rendition

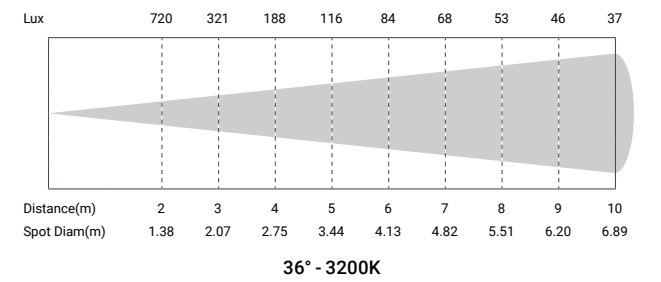
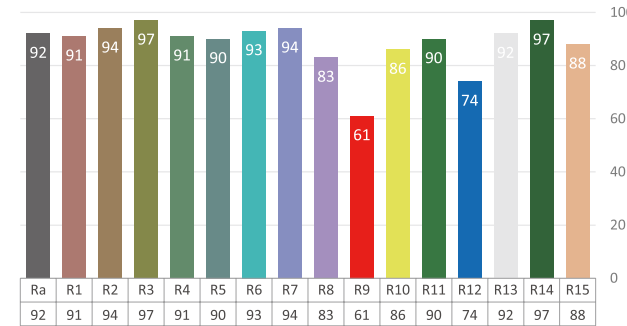

Technical Data

Power supply:	AC100 - 240V, 50/60Hz	Control mode:	DMX, track mount version optional
Light source:	20W COB LED	Housing:	Color black, die-casting aluminum
Color temperature:	3200K or 5600K	Size:	343.7 x 133 x 131mm
Fixed lens:	19°, 26°, 36°, 50° optional	N.W.:	1.5 kg
Color Rendition:	CRI 92	Accessories(incl.):	Power cable, gel frame
Power connection:	Dedicated power in	Accessories(opt.):	Gobo holder E sized, Clamp, Safety rope
Signal connection:	3-pin XLR in & out	Environment:	IP20
Control channels	1		

THEATRICAL LIGHTING

THEATRICAL LIGHTING



S20T

20W tunable LED profile spot



S20T is a tiny 20W tunable COB LED profile spot. Die-casting housing, fan-free design. With 19°, 26°, 36°, 50° lens optional, and portable, track mount version selectable. It's an idea product for art gallery, Museum, Shopping mall.

Key features:

- 20W WW+20W CW constant COB LED, high lumen
- 2700K- 6000K color temp adjustable
- High CRI of 92
- Even wash of light
- Die-casting aluminum housing, fan-free
- 19°, 26°, 36°, 50° lens selectable
- Smooth dimming, flicker free
- Compact body, easy to set up

Application:

- Museum
- Theatre, church
- Shopping mall
- Art gallery
- Restaurant

Accessories:

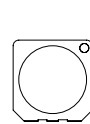

Gel frame

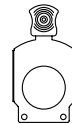

Gobo holder E sized (opt.)



Photometric

WW(lx)	2840	739	357	195	141
CW(lx)	4090	1110	496	251	191
Full on(lx)	3690	994	451	237	174

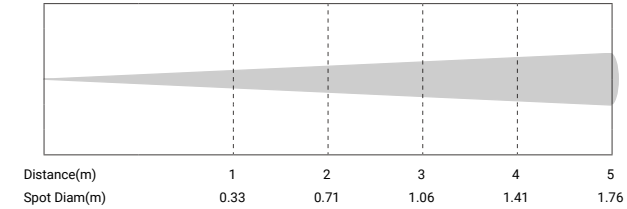

19°

WW(lx)	811	242	113	76	47
CW(lx)	1140	339	156	92	69
Full on(lx)	1030	292	143	90	60

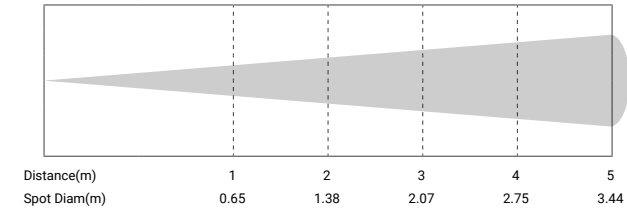

36°

WW(lx)	1936	527	253	139	107
CW(lx)	2700	764	357	189	134
Full on(lx)	2450	706	307	172	127

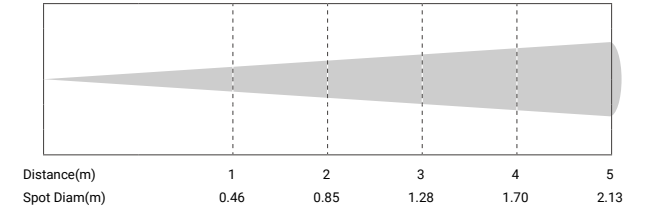

26°

WW(lx)	581	174	81	52	47
CW(lx)	843	232	116	75	53
Full on(lx)	477	211	103	65	52

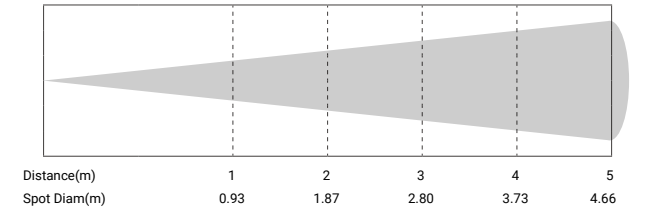

50°

Technical Data

Power supply:	AC100 - 240V, 50/60Hz
Light source:	20W WW + 20W CW
Color temperature:	2700K - 6000K adjustable
Fixed lens:	19°, 26°, 36°, 50° optional
Color Rendition:	CRI 92
Power connection:	Dedicated power in
Signal connection:	3-pin XLR in & out
Control channels	1/2/3/5

Control mode:	DMX, track mount version optional
Housing:	Color black, die-casting aluminum
Size:	343.7 x 133 x 131mm
N.W.:	1.7 kg
Accessories(incl.):	Power cable, gel frame
Accessories(opt.):	Gobo holder E sized, Clamp, Safety rope
Environment:	IP20



MINI PROFILE 40Z

WW / CW

40W LED profile zoom

Mini Profile 40Z is a mini 40W COB LED profile spot. Die-casting housing, fan-free design. With 15 - 30° zoom lens, and portable, track mount version selectable. It's an idea product for art gallery, museum, shopping mall.

Key features:

- 40W COB LED
- 3200K or 5600K color temp
- High CRI of 92
- Die-casting aluminum housing, fan-free
- 15° - 30° zoom lens
- Smooth dimming, flicker free
- Compact body, easy to set up
- Rotary, DMX control of dimmer(portable ver.)
- RDM function available
- Track mount version selectable

Application:

- Museum
- Theatre, church
- Shopping mall
- Art gallery
- Restaurant

Accessories:

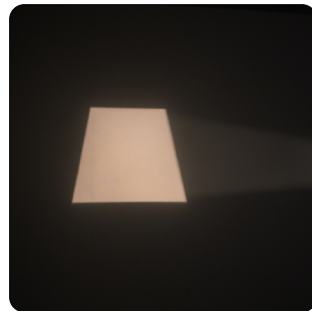
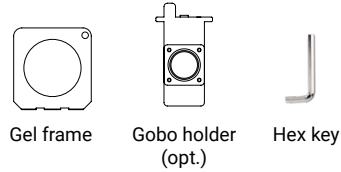

*white body version



*track mount version opt.

Photometric

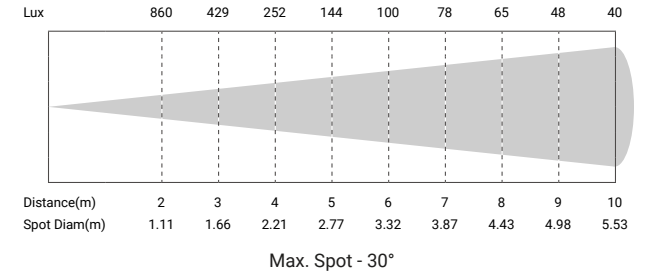
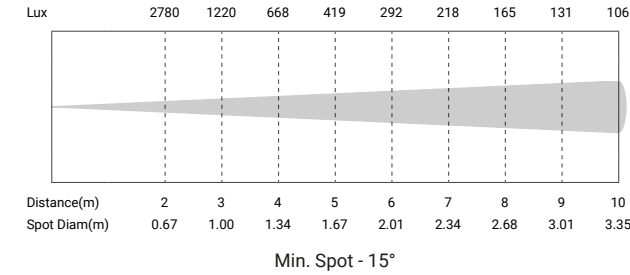

Color Rendition

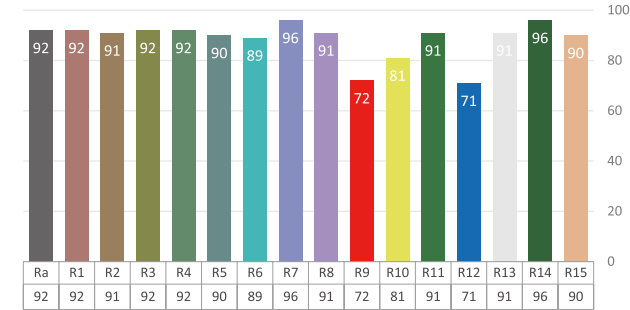

Technical Data

Power supply:	AC100 - 240V, 50/60Hz	Control mode:	Rotary, DMX, RDM
Light source:	40W COB LED	Housing:	Color black, die-casting aluminum
Color temperature:	3200K or 5600K	Size:	402 x 180 x 230mm
Zoom range:	15° - 30°	N.W.:	2.3 kg
Color Rendition:	CRI 92	G.W.:	3 kg
Power connection:	Dedicated power in	Accessories(incl.):	Power cable, gel frame
Signal connection:	3-pin XLR in & out(5-pin optional)	Accessories(opt.):	Gobo holder, Clamp, Safety rope
Control channels:	1	Environment:	IP20

THEATRICAL LIGHTING

THEATRICAL LIGHTING



S40T

40W tunable LED profile spot

S40T is a 40W tunable COB LED profile spot. Die-casting housing, fan-free design. With 15° - 30° zoom lens, color temperature 2700K - 6000K. It's an idea product for art gallery, museum, shoping mall.



Key features:

- 40W WW+40W CW constant output LED
- 2700K - 6000K adjustable
- High CRI of 92
- Die-casting aluminum housing, fan-free
- 15° - 30° zoom lens
- Smooth dimming, flicker free
- Compact body, easy to set up
- DMX control of dimmer
- RDM function available

Application:

- Museum
- Theatre, church
- Shopping mall
- Art gallery
- Restaurant

Accessories:

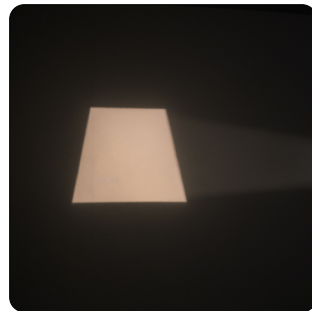
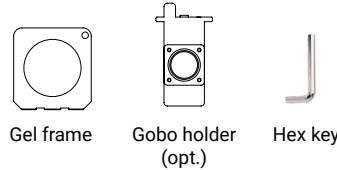

Photometric

WW(lx)	9130	2850	1280	758	500
CW(lx)	12100	3790	1690	995	650
Full on (lx)	9120	2950	1320	770	514

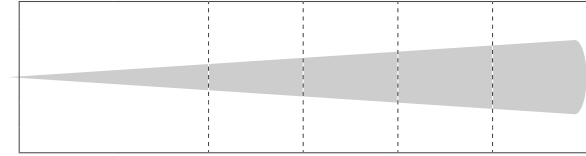

Distance(m)	1	2	3	4	5
Spot Diam(m)	0.26	0.67	1.00	1.34	1.67

Min. Spot - 15°

WW(lx)	4240	1280	526	354	244
CW(lx)	4670	1600	744	460	288
Full on (lx)	4360	1260	553	381	245

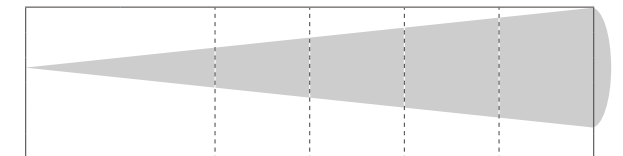

Distance(m)	1	2	3	4	5
Spot Diam(m)	0.54	1.11	1.66	2.21	2.77

Max. Spot - 30°

Color Rendition - 4000K

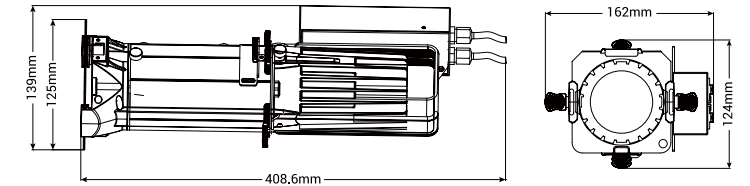
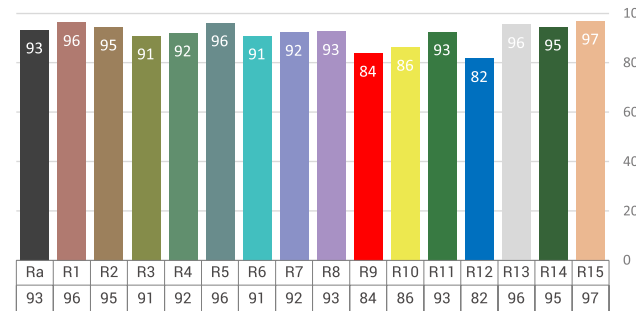

Technical Data

Power supply:	AC100 - 240V, 50/60Hz
Light source:	40W WW + 40W CW
Color temperature:	2700K - 6000K adjustable
Zoom range:	15° - 30°
Color Rendition:	Avg. CRI 92
Power connection:	Dedicated power in
Signal connection:	3-pin XLR in & out
Control channels:	1/2/3/5

Control mode:	DMX, RDM
Housing:	Color black, die-casting aluminum
Size:	408 x 162 x 124mm
N.W.:	2.3 kg
G.W.:	3 kg
Accessories(incl.):	Power cable, Gel frame
Accessories(opt.):	Gobo holder, Clamp, Safety rope
Environment:	IP20



HONOR 250C ZOOM

250W RGBW profile zoom

The Honor 250C Zoom is a 250W LED profile spot with RGBW color mixing. A good replacement of the tungsten source. The 18-38° all-in-one zoom range covers the most regular 19°, 26°, 36° lens.

Key features:

- 250W RGBW LED
- 3000K ~ 8000K color temp
- HQ optical system, clean shutter cuts beam
- 18-38° "all-in-one" zoom range
- Smooth dimming, flicker free
- Rotary, Key, DMX control of dimmer
- Intelligent temperature control
- Engine and lens compatible with industry standard

Application:

- Theatre, church
- Museum
- Exhibition lighting

Accessories:

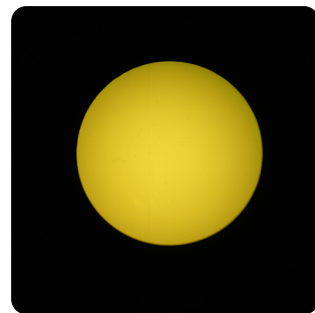
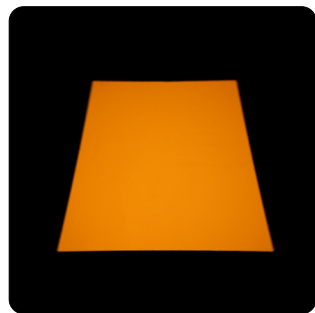
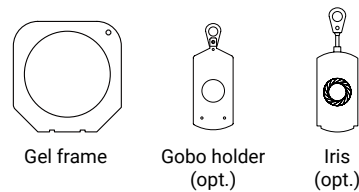

Photometric

R(lx)	680	365	263	222	176	135	63
G(lx)	119	654	489	422	337	254	117
B(lx)	282	162	118	95	78	54	29
W(lx)	1940	1060	817	695	562	425	197
Full on(lx)	3840	2100	1580	1380	1100	839	390

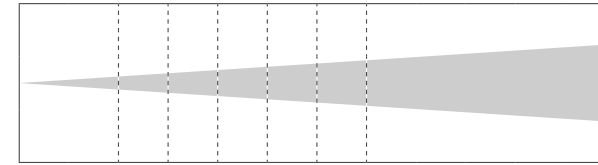

Distance(m)	5	6	7	8	9	10	15
Spot Diam(m)	1.49	1.79	2.09	2.39	2.69	2.99	4.48

Min. Spot - 18°

R(lx)	234	164	112	85	68	56	27
G(lx)	414	281	207	160	126	102	52
B(lx)	101	64	53	42	30	24	13
w(lx)	682	450	345	263	213	125	89
Full on(lx)	1330	879	672	513	411	350	65

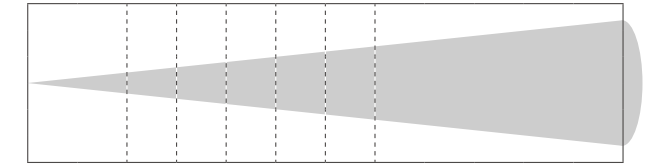

Distance(m)	5	6	7	8	9	10	15
Spot Diam(m)	2.85	3.42	3.99	4.56	5.13	5.7	8.55

Max. Spot - 38°

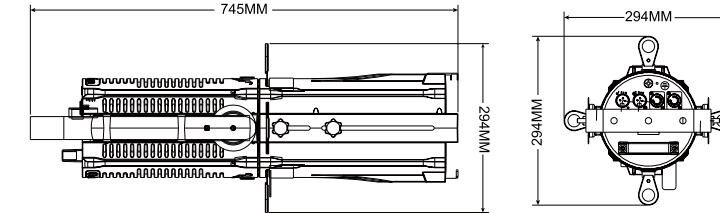

Technical Data

Power supply:	AC100 - 240V, 50/60Hz	Housing:	Color black, engineering plastic
Light source:	250W LED	Size:	745 x 294 x 294mm
Color mixing:	RGBW	Package(carton):	790 x 350 x 360mm
Color temperature:	3000K ~ 8000K tunable	N.W.:	8.7 kg
Zoom range:	18°-38° , 5°-10° , 9°-18° optional	G.W.:	11.5 kg
Power connection:	PowerCON in & out	Accessories(incl.):	Power cable, Gel frame, Safety rope
Signal connection:	3-pin XLR in & out(5-pin optional), Net in & out-(opt.)	Accessories(opt.):	Gobo holder, Clamp
Control channels:	1/4/6/10	GOBOSize:	OD 58mm, image area 50mm
Control mode:	Rotary, DMX, RDM	Compliance:	CE
		Environment:	IP20

THEATRICAL LIGHTING

THEATRICAL LIGHTING

- 3200K/5600K
- RDM Control
- COB 300W LED
- ZOOM
- Flicker Free
- 98 TLCI
- 97 CRI
- ARNet Optional

Powered by 300W 3200K or 5600K LED, the Honor 300 Zoom is designed to replace the 1K Tungsten Halogen profile light. The 18-38° "all-in-one" zoom range covers the most regular 19°, 26°, 36° lens. It creates a flat and even field of light and crisp pattern projection.

Key features:

- 300W COB white LED
- CRI 97, R9≥90, TLCI up to 98
- HD optical system, clean shutter cuts beam
- 18-38° "all-in-one" zoom range
- 16 bit dimming via DMX
- Flicker free with selectable PWM
- Rotary, key, DMX control of dimmer
- Silent operation for studio and theatre use
- Artnet version optional
- Engine and lens compatible with industry standard

Application:

- Broadcast, HD studio
- Theatre, church
- Fashion show
- Museum
- Exhibition lighting

Accessories:

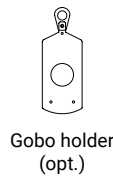
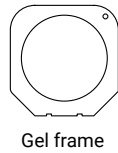

HONOR 300 ZOOM

WW / CW

300W LED profile zoom



Photometric

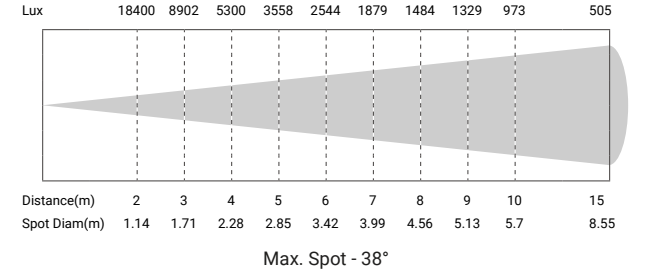
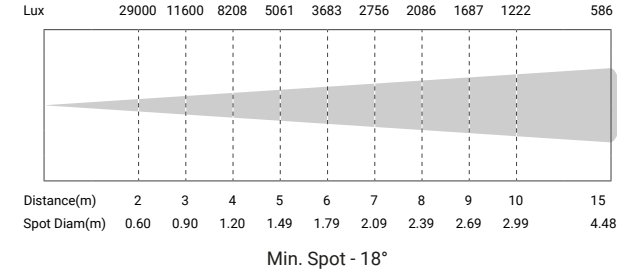

Color Rendition

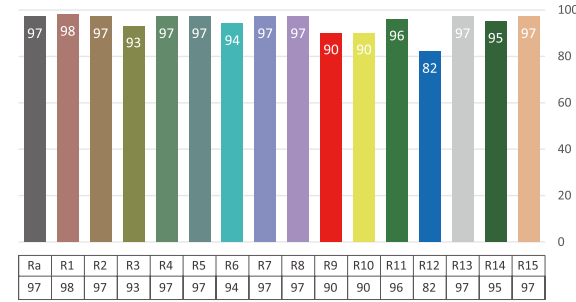

Technical Data

Power supply:	AC100 - 240V, 50/60Hz
Light source:	300W COB LED
Color temperature:	3200K or 5600K
Zoom range:	18°-38°, 5°-10°, 9°-18° optional
Color Rendition:	CRI 97, R9≥90, TLCI 98, CQS 94
Power connection:	PowerCON in & out
Signal connection:	3-pin XLR in & out(5-pin opt.), Net in & out(opt.)
Control channels:	1/2/3
Control mode:	Rotary, DMX, RDM and Art-Net(optional)
Housing:	Color black, engineering plastic

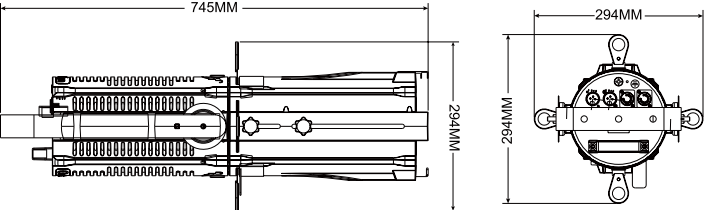

Size:	745 x 294 x 294mm
Package(carton):	790 x 350 x 360mm
N.W.:	8.7 kg
G.W.:	11.5 kg
Accessories(incl.):	Power cable, gel frame, Safety rope
Accessories(opt.):	Gobo holder, Clamp
GOBOSize:	OD 58mm, image area 50mm
Compliance:	CE
Environment:	IP20

2800K - 6500K
300W tunable
RDM Control
ZOOM
 Flicker Free
98 TLCI
97 CRI

CTC 300 PROFILE

300W + 300W tunable LED profile zoom

CTC 300 Profile equipped with a 600W LED (300W WW+300W CW constant output). 2800K - 7000K color temperature adjustable. A good replacement of the tungsten source. The 18-38° all-in-one zoom range covers the most regular 19°, 26°, 36° lens.

Key features:

- 300W tunable white LED
- 300W WW+300W CW, 2800K-6500K adjustable
- High CRI of 97, R9≥97
- HD optical system, clean shutter cuts beam
- 18° - 38° "all-in-one" zoom range
- Smooth dimming
- Video flicker free
- Rotary, key, DMX, RDM control of dimmer
- Intelligent temperature control, silent operation for studio and theater use

Application:

- Broadcast, HD studio
- Theatre, church
- Fashion show
- Museum
- Exhibition lighting

Accessories:

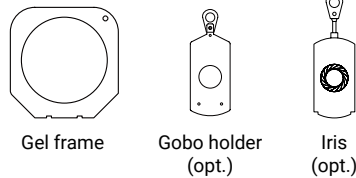

Photometric

WW 2700K(lx)	12000	4700	2720	1770	1220	928	709	583	472
CW 7000K(lx)	16300	6320	3680	2420	1640	1250	957	783	640
Full on 4000K(lx)	17600	6930	4020	2620	1810	1390	1040	860	701

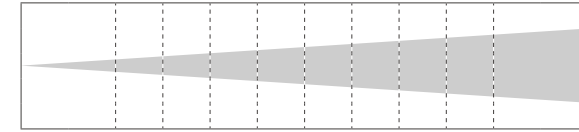

Distance(m)	2	3	4	5	6	7	8	9	10
Spot Diam(m)	0.60	0.90	1.20	1.49	1.79	2.09	2.39	2.69	2.99

Min. Spot - 18°

WW 2700K(lx)	9750	3900	2390	1650	1150	885	701	484	414
CW 7000K(lx)	13200	5080	3190	1640	1560	1190	951	801	670
Full on 4000K(lx)	14300	5710	3050	2410	1700	1290	1040	879	730

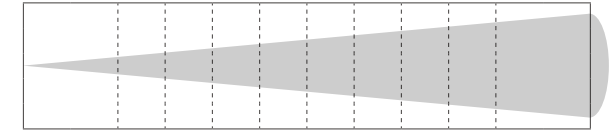

Distance(m)	2	3	4	5	6	7	8	9	10
Spot Diam(m)	1.14	1.71	2.28	2.85	3.42	3.99	4.56	5.13	5.7

Max. Spot - 38°

Color Rendition



Technical Data

Power supply:	AC100-240V, 50/60Hz
Light source:	300W tunable LED
Color temperature:	2800K - 6500K
Zoom range:	18° - 38°
Color Rendition:	CRI 97, R9≥97, TLCI 98
Power connection:	PowerCON in & out
Signal connection:	3-pin XLR in & out(5-pin opt.)
Control channels:	2/3
Control mode:	Rotary, DMX, RDM
Housing:	Color black, engineering plastic

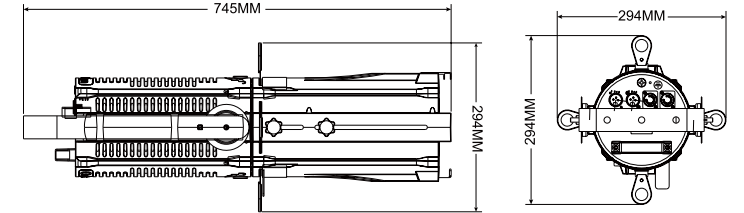

Size:	745 x 294 x 294mm
Package(carton):	790 x 350 x 360mm
N.W.:	8.7 kg
G.W.:	11.5 kg
Accessories(incl.):	Power cable, gel frame, Safety rope
Accessories(opt.):	Iris, Gobo holder, Clamp
GOBOSize:	OD 58mm, image area 50mm
Compliance:	CE
Environment:	IP20



HONOR 350C ZOOM

350W 6 color profile zoom

The Honor 350C Zoom is a 350W LED profile spot with RGBALC color mixing. A good replacement of the tungsten source. It creates a flat and even color mixing.

Key features:

- 350W RGBALC six color LED
- Super flat and even color mixing
- 3000K - 8000K color temperature
- 18 - 38° "all-in-one" zoom range
- Smooth dimming, flicker free
- High CRI of 95, TLCI 95(CT channel)
- Rotary, key, DMX control of dimmer
- Intelligent temperature control
- Engine and lens compatible with industry standard

Application:

- Theatre, church
- Museum
- Exhibition lighting

Accessories:

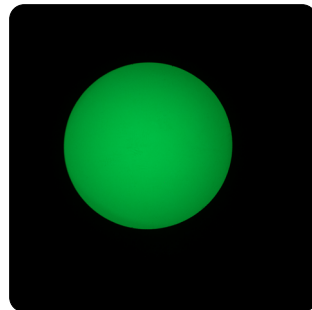
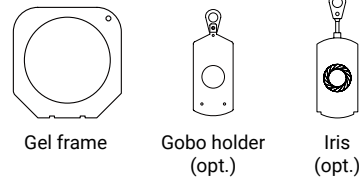

Photometric

R(lx)	405	95	51
G(lx)	680	160	85
B(lx)	79	31	22
A(lx)	1440	340	181
L(lx)	2260	510	281
C(lx)	430	102	54
Full on(lx)	4850	1120	618

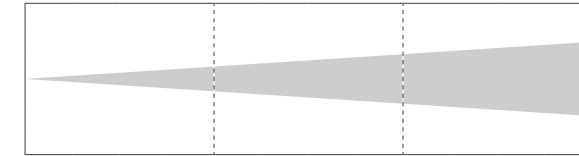

Distance(m)	5	10	15
Spot Diam(m)	1.49	2.99	4.48

Min. Spot - 18°

Color Temperature Channel-CRI

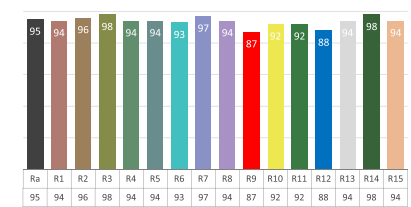

Technical Data

Power supply:	AC100 - 240V, 50/60Hz
Light source:	350W RGBALC LED
Color mixing:	RGBALC(amber, lime, cyan)
Color temperature:	3000K - 8000K tunable
Zoom range:	18° - 38°
Color Rendition:	CRI, TLCI≥95(CT channel), CRI 85(full on)
Power connection:	PowerCON in & out
Signal connection:	3-pin XLR in & out, 5-pin XLR in & out
Control channels:	2/8/12
Control mode:	Rotary, DMX and RDM

R(lx)	128	36	51
G(lx)	229	57	30
B(lx)	62	15	8
A(lx)	495	125	68
L(lx)	749	196	104
C(lx)	146	36	20
Full on(lx)	1550	420	220

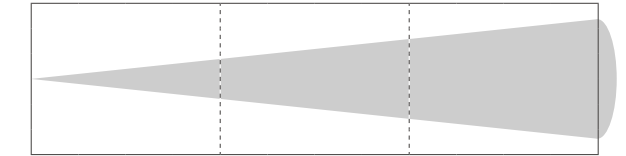

Distance(m)	5	10	15
Spot Diam(m)	2.85	5.7	8.55

Max. Spot - 38°

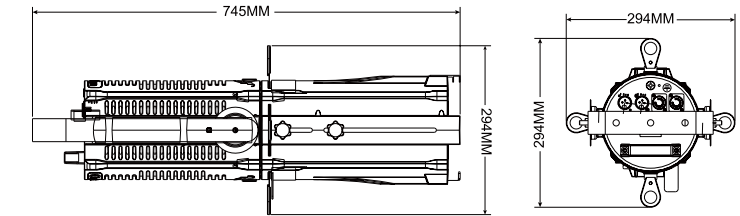

Housing:	Color black, engineering plastic
Size:	745 x 294 x 294mm
Package(carton):	790 x 350 x 360mm
N.W.:	8.7 kg
G.W.:	11.5 kg
Accessories(incl.):	Power cable, Gel frame, Safety rope
Accessories(opt.):	Gobo holder, Clamp
GOBOSize:	OD 58mm, image area 50mm
Compliance:	CE
Environment:	IP20

THEATRICAL LIGHTING

THEATRICAL LIGHTING

- 

3200K/5600K
- 

RDM
Optional
- 

COB
300W LED
- 

ZOOM
- 

Flicker Free
- 

98
TLCI
- 

97
CRI
- 

NET
Optional

Just by replace the lens tube without any tools, the Honor profile spot turns to a LED fresnel zoom. Featuring 300W high power 3200K/5600K LED, 97 CRI and 90 R9, flat and even field of light. It is designed to replace the traditional tungsten fresnels. The no noise operation makes it idea for studio and theatre.

HONOR 300 FRESNEL

WW / CW

300W LED fresnel zoom

Key features:

- 300W COB white LED
- 3200K or 5600K color temperature
- CRI 97, R9≥90, TLCI up to 98
- Tool-free replacement between profile and fresnel
- Manual zoom function
- Smooth dimming, flicker free
- Rotary, key, DMX control of dimmer
- Intelligent temperature control, silent operation for studio and theatre use

Application:

- Broadcast, HD studio
- Theatre, church
- Fashion show
- Museum
- Exhibition lighting

Accessories:

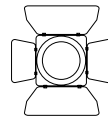

Barn door

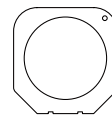

Gel frame



Photometric

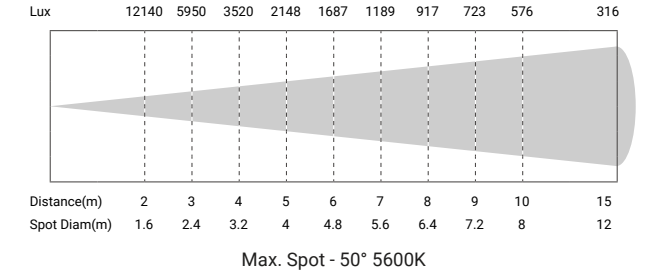
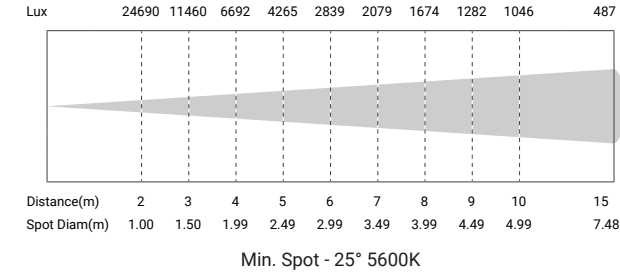

Color Rendition

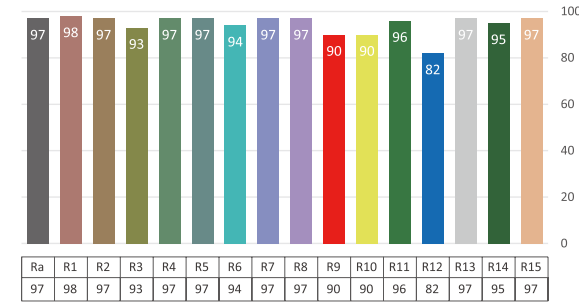

Technical Data

Power supply:	AC100 - 240V, 50/60Hz
Light source:	300W COB LED
Color temperature:	3200K or 5600K
Zoom range:	25°- 50° manual zoom
Color Rendition:	CRI 97, R9≥90, TLCI 98, CQS 94
Power connection:	PowerCON in & out
Signal connection:	3-pin XLR in & out(5-pin opt.), Net in & out(opt.)
Control channels:	1/2/3
Control mode:	Rotary, DMX, Art-Net and RDM(optional)

Housing:	Color black, engineering plastic
Size:	562 x 248 x 189.4mm
Package(carton):	630 x 350 x 360mm
N.W.:	7.3 kg
G.W.:	10.5 kg
Accessories(incl.):	Power cable, barn door, Gel frame, Safety rope
Accessories(opt.):	Clamp
Compliance:	CE
Environment:	IP20

3200K/5600K RDM Control COB 40W LED ZOOM Flicker Free 98 TLCI 95 CRI

Designed for short distance wash. The mini Fresnel 40Z is a compact LED fresnel and powered by 40W 3200K tungsten or 5600K daylight LED. Featuring 25-80° zoom, 95CRI, 90 R9, rotary control of dimmer. It deliver a smooth, soft flat field of light. Barn door included for the shape of the light.

Key features:

- 40W COB white LED
- CRI 95, R9≥90, TLCI 98, CQS 94
- 25° - 80° manual zoom
- Smooth dimming, flicker free
- Super compact, easy for set up
- Rotary, key, DMX control of dimmer
- DMX-RDM compliant
- 4-leaf rotatable barndoor included
- Track mount version selectable

Application:

- News interview
- Micro film shooting
- Small event
- Wedding shooting
- Exhibition lighting

Accessories:

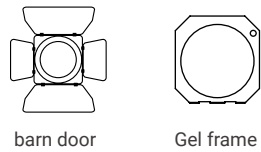

MINI FRESNEL 40Z

WW / CW

40W LED fresnel zoom

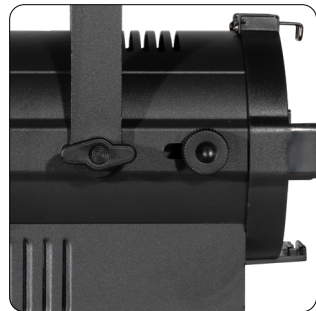

Photometric

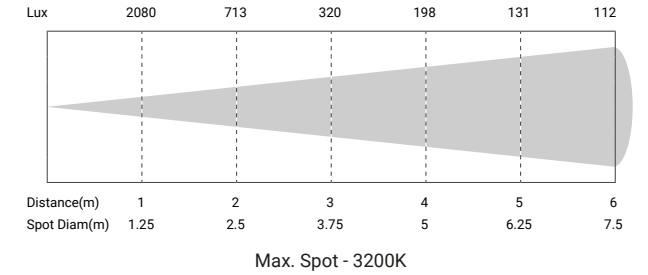
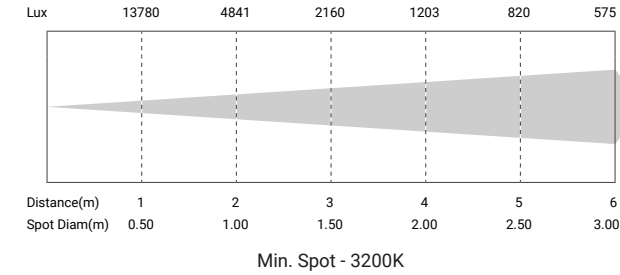

Color Rendition

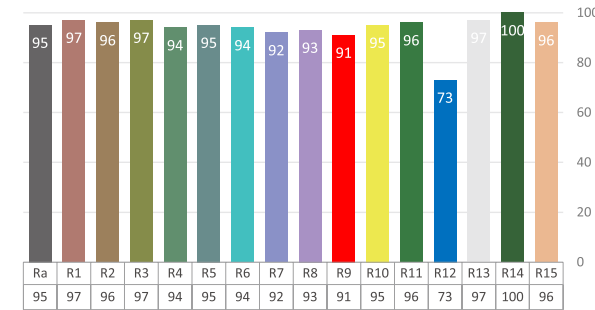

Technical Data

Power supply:	AC100 - 240V, 50/60Hz
Light source:	40W COB LED
Color temperature:	3200K or 5600K
Zoom range:	25° - 80° manual zoom
Color Rendition:	CRI 95, R9≥90, TLCI 98, CQS 94
Power connection:	PowerCON in
Signal connection:	3-pin XLR in & out(5-pin optional)
Control channels:	1/2/3/4
Control mode:	DMX, RDM, Rotary
Dimmer speed:	4 grade

Housing:	Colour black, Aluminum
Size:	230 x 156 x 279mm
Package(carton):	335 x 218 x 220mm
N.W.:	2.2 kg(barn door incl.)
G.W.:	2.8 kg
Accessories(incl.):	Power cable, barn door, Gel frame
Accessories(opt.):	Clamp, Safety rope
Compliance:	CE
Environment:	IP20

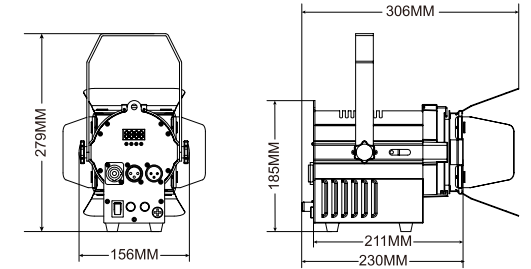

THEATRICAL LIGHTING

THEATRICAL LIGHTING



MINI FRESNEL 50TZ

50W tunable fresnel zoom

The Mini Fresnel 50TZ is a compact LED fresnel and powered by 50W warm white and 50W cold white tunable LED. 25° ~ 80° zoom, 95CRI, 90 R9, rotary control of dimmer. It deliver a smooth, soft flat field of light. Barn door included for the shape of the light.

Key features:

- 50W warm white + 50W cool white
- 2700K ~ 6500K tunable
- CRI 95, R9≥90, TLCI 98, CQS 96
- 25° - 80° manual zoom
- Smooth dimming, flicker free
- Super compact, easy for set up
- Rotary, key, DMX control of dimmer
- DMX-RDM compliant
- 4-leaf rotatable barndoor included
- Track mount version selectable

Application:

- News interview
- Micro film shooting
- Small event
- Wedding shooting
- Exhibition lighting

Accessories:

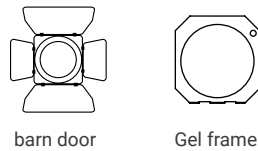

Photometric

WW(lx)	6419	2986	946	543	352	240
CW(lx)	8804	2843	1312	759	495	329
Full on(lx)	7063	2216	1069	610	396	270

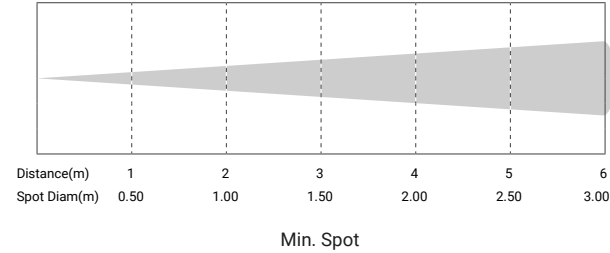

WW(lx)	1955	602	291	165	114	80
CW(lx)	2688	866	395	230	155	110
Full on(lx)	2150	698	319	185	126	90

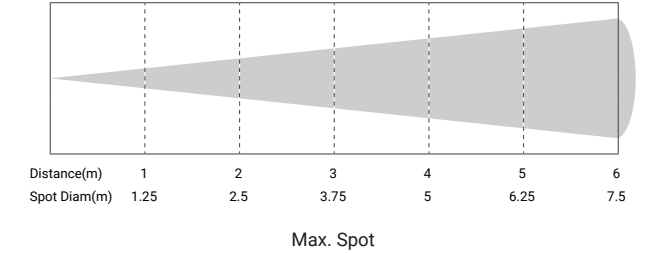

Color Rendition

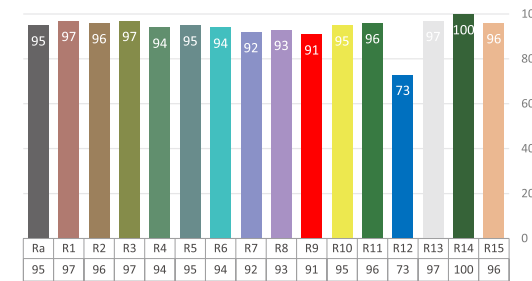

Spectrum

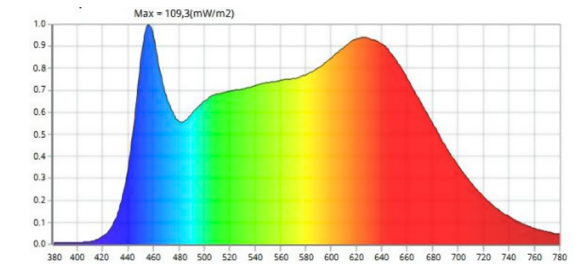

Technical Data

Power supply:	AC100 - 240V, 50/60Hz
Light source:	50W WW + 50W CW
Color temperature:	2700K ~ 6500K tunable
Zoom range:	25° - 80° manual zoom
Color Rendition:	CRI 95, R9≥90, TLCI 98, CQS 96
Power connection:	PowerCON in
Signal connection:	3-pin XLR in & out(5-pin optional)
Control channels:	1/2/3/5
Control mode:	DMX, RDM, Rotary

Housing:	Colour black, Aluminum
Size:	230 x 156 x 279mm
Package(carton):	335 x 218 x 220mm
N.W.:	2.2 kg(barn door incl.)
G.W.:	2.8 kg
Accessories(incl.):	Power cable, barn door, Gel frame
Accessories(opt.):	Clamp, Safety rope
Compliance:	CE
Environment:	IP20

THEATRICAL LIGHTING

THEATRICAL LIGHTING



MINI FRESNEL 40CZ

40W RGBW LED fresnel zoom

Mini Fresnel 40CZ is a portable LED fresnel and powered by 40W RGBW LED. Featuring 25-80° zoom, even color mixing, 3000K ~ 8000 color temp. It deliver a smooth, soft flat field of light. Barn door included for the shape of the light.

Key features:

- 40W LED(40W R+40W G+40W B+40W W)
- RGBW flat and even color mixing
- 25° - 80° manual zoom
- Smooth dimming, flicker free
- Super compact, easy for set up
- Rotary, key, DMX control of dimmer
- DMX-RDM compliant, 4 dimmer modes
- 4-leaf rotatable barndoor included
- Track mount version selectable

Application:

- Small event
- Small theatre
- Stage wash

Accessories:

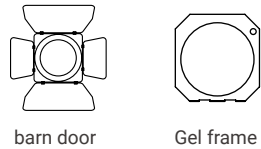

barn door

Gel frame



Photometric

R(lx)	273	125	72	43	36	26	23	17	13
G(lx)	620	295	170	108	83	63	58	41	33
B(lx)	151	82	52	33	27	17	15	11	9
W(lx)	740	328	199	132	95	75	69	53	37
Full on(lx)	438	207	120	75	60	43	37	29	25

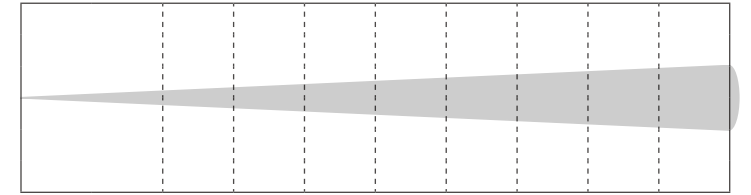

Distance(m)	2	3	4	5	6	7	8	9	10
Spot Diam(m)	3.18	4.77	6.36	7.95	9.55	11.14	12.73	14.32	15.91

Max. Spot

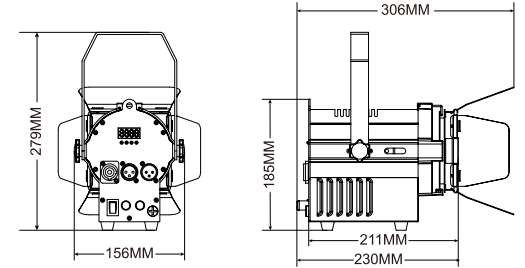

Technical Data

Power supply:	AC100 - 240V, 50/60Hz	Dimmer speed:	4 grade
Light source:	40W LED	Housing:	Colour black, Aluminum
LED color:	40W R+40W G+40W B+40W W	Size:	230 x 156 x 279mm
Color temperature:	3000K ~ 8000K	Package(carton):	335 x 218 x 220mm
Zoom range:	25° - 80° manual zoom	N.W.:	2.2 kg(barn door incl.)
Power connection:	PowerCON in	G.W.:	2.8 kg
Signal connection:	3-pin XLR in & out(5-pin optional)	Accessories(incl.):	Power cable, barn door, Gel frame
Control channels:	ARC.1(3CH), AR1.D(4CH), ARC.2(4CH), AR2.D(5CH), AR2.S(6CH), HSV(3CH), STAG(11CH)	Accessories(opt.):	Clamp, Safety rope
Control mode:	DMX, RDM	Compliance:	CE
		Environment:	IP20

THEATRICAL LIGHTING

THEATRICAL LIGHTING

2700K - 6000K	COB 40W LED	Flicker Free	92 CRI	88 TLCI
---------------	----------------	--------------	------------------	-------------------

Art 50 Wash is a compact LED fresnel, 10°-60° zoom, suitable for projection from different distances. Die-casting housing, fan-free design. Color temperature adjustable from 2700K - 6000K. It's an idea product for art gallery, museum, shopping mall.

Key features:

- 40W WW + 40W CW constant output LED
- 2700K - 6000K adjustable
- High CRI over 92
- 10°-60° manual zoom
- Die-casting aluminum housing, fan-free
- Smooth dimming, flicker free
- Compact body, easy to set up
- DMX control of dimmer
- RDM function available
- Front barrel innovative focusing

Application:

- Museum
- Theatre, church
- Shopping mall
- Art gallery
- Restaurant

ART 50 WASH
40W tunable LED fresnel



Photometric

CW (lx)	8550	2620	1270	732	504
CW (lx)	10400	3280	1400	621	630
Full on (lx)	9750	2940	1370	750	567

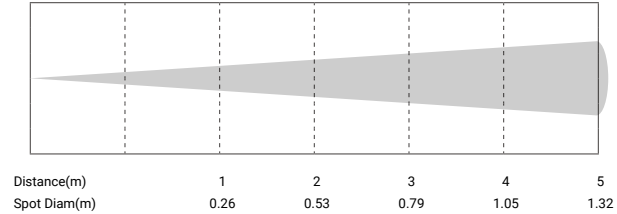

15°

WW (lx)	1300	454	226	150	103
CW (lx)	1690	553	285	185	130
Full on (lx)	15102	4962	260	168	116

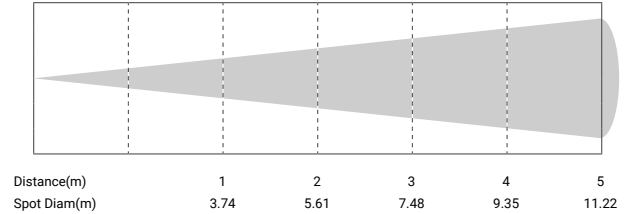

30°

Color Rendition - 2700K

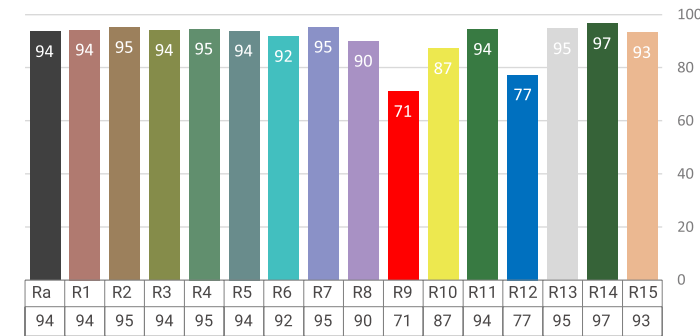

Technical Data

Power supply:	AC100-240V, 50/60Hz
Light source:	40W WW + 40W CW LED
Color temperature:	2700K - 6000K adjustable
Zoom range:	10° - 60° manual zoom
Color Rendition:	Avg. CRI 92
Power connection:	Power in
Signal connection:	3-pin XLR in & out

Control channels:	1/2/3/5
Control mode:	DMX, RDM
Housing:	Color black, die-casting aluminum
Size:	258x140x90mm
G.W.:	1.3 kg
Environment:	IP20



PIONEER 100 ZOOM

WW / CW

100W LED fresnel zoom

The Pioneer 100 Zoom is a 100W 3200K or 5600K powered LED fresnel with zoom function. The RDM-DMX compliant, 25 - 65 degree motorized zoom along with it's superior 97 CRI make this fixture a good replacement for the traditional fresnels.

Key features:

- 100W COB white LED
- 3200K or 5600K color temperature
- CRI 97, R9≥90, TLCI 98, CQS 94
- Soft and even wash effect
- 25° - 65° motorized zoom
- Smooth dimming, flicker free
- DMX, RDM control
- Dimmer curves selectable
- Silent operation for studio and theatre

Application:

- Broadcast, HD studio
- Theatre, church
- Film shooting
- Museum
- Exhibition lighting

Accessories:

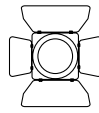

Barn door

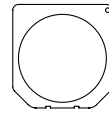

Gel frame

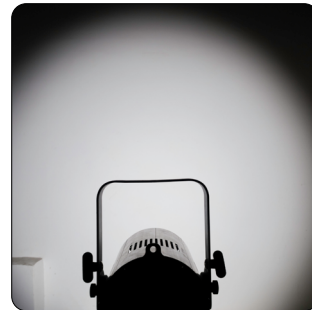

Photometric

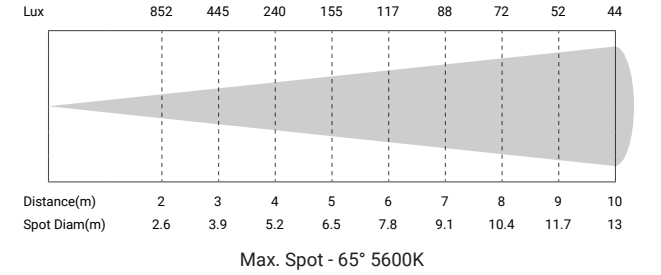
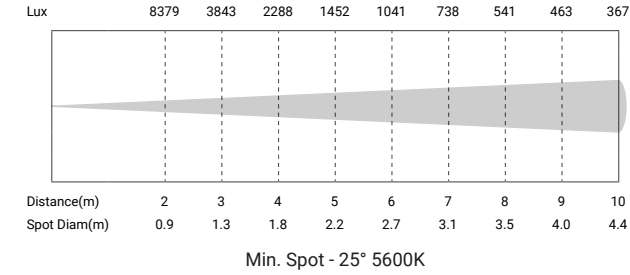

Color Rendition

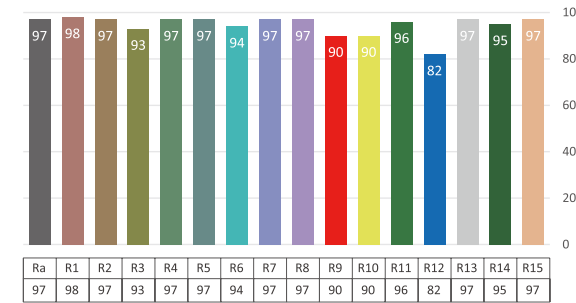

Technical Data

Power supply:	AC100 - 240V, 50/60Hz
Light source:	100W COB LED
Color temperature:	3200K or 5600K
Zoom range:	25° - 65° motorized zoom
Color Rendition:	CRI 97, R9≥90, TLCI 98, CQS 94
Power connection:	PowerCON in & out
Signal connection:	3-pin XLR in & out(5-pin optional)
Control channels:	2/3/4/5
Control mode:	DMX and RDM
Dimmer speed:	4 grade

Housing:	Colour black, Aluminum
Size:	331 x 210 x 345.7mm
Package(carton):	448 x 338 x 400mm
N.W.:	6.6 kg(barn door incl.)
G.W.:	7.6 kg
Accessories(incl.):	Power cable, barn door, gel frame, safety rope
Accessories(opt.):	Clamp
Compliance:	CE
Environment:	IP20

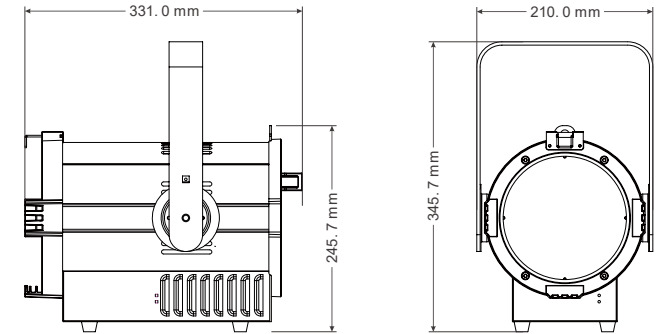



PIONEER 100T ZOOM

100W tunable LED fresnel zoom

The Pioneer 100T zoom is a 100Watt WW + 100Watt CW powered LED fresnel with zoom function. The RDM-DMX compliant, 25 - 65 degree manual zoom along with it's superior 95 CRI make this fixture a good replacement for the traditional fresnels.

Key features:

- 100Watt WW + 100W CW COB white LED
- 2700K - 6000K tunable color temperature
- Average CRI 95, TLCI 97
- Soft and even wash effect
- 25° - 65° moto zoom
- Smooth dimming, flicker free
- DMX, RDM control
- Dimmer curves selectable
- Silent operation for studio and theatre

Application:

- Broadcast, HD studio
- Theatre, church
- Film shooting
- Museum
- Exhibition lighting

Accessories:

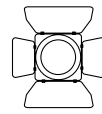

Barn door

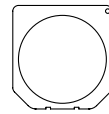

Gel frame

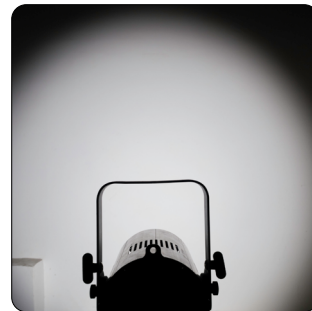
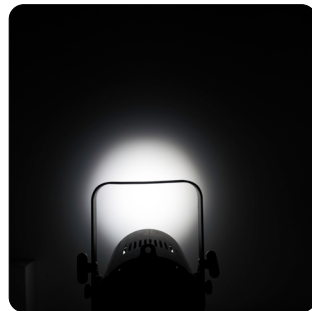

Photometric

WW(lx)	12000	3130	1520	812	204
CW(lx)	18200	4580	2020	1220	806
Full on(lx)	13000	3280	1390	882	573

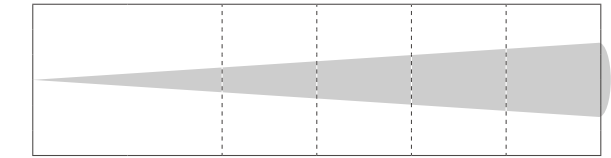

Distance(m)	1	2	3	4	5
Spot Diam(m)	0.43	0.85	1.28	1.70	2.13

Min. Spot - 25°

WW(lx)	3800	1040	487	283	190
CW(lx)	5350	1400	643	382	262
Full on(lx)	4200	1050	467	289	195

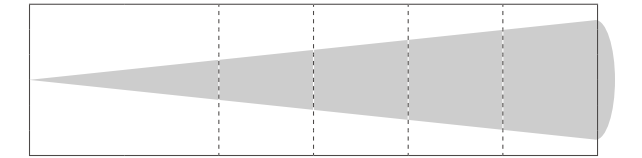

Distance(m)	1	2	3	4	5
Spot Diam(m)	1.33	2.67	4	5.33	6.67

Max. Spot - 65°

Color Rendition - 2700K

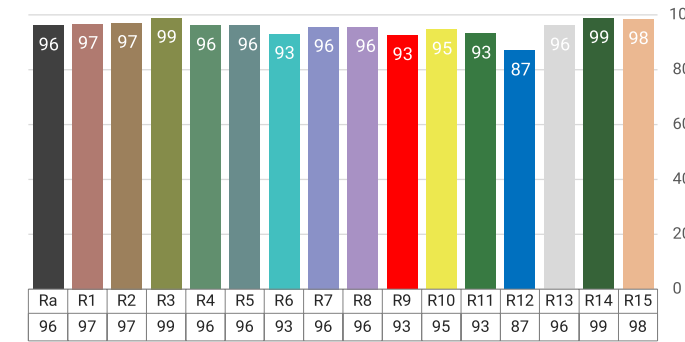

Technical Data

Power supply:	AC100-240V, 50/60Hz
Light source:	100Watt WW + 100W CW LED
Color temperature:	2700K - 6000K
Zoom range:	25° - 65° motorized zoom
Color Rendition:	Average CRI 95, TLCI 97
Power connection:	PowerCON in & out
Signal connection:	3-pin XLR in & out
Control channels:	2/3/6/7 CH
Control mode:	DMX, RDM, Master-slave

Housing:	Colour black, Aluminum
Package(carton):	448 x 338 x 400mm
Size:	331 x 210 x 345.7mm(13 x 8.3 x 13.6in)
N.W.:	6.6 kg(barn door incl.)
G.W.:	7 kg
Accessories(incl.):	Power cable, barn door, gel frame, safety rope
Accessories(opt.):	Clamp
Compliance:	Pending
Environment:	IP20

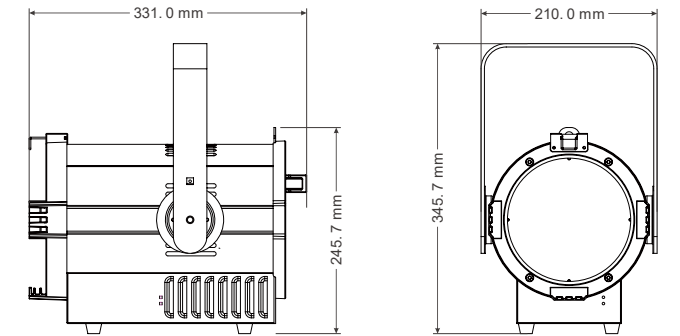



PIONEER 100C ZOOM

100W LED RGBW fresnel zoom

The Pioneer 100C Zoom is a 100W RGBW LED fresnel with zoom function. The RDM-DMX compliant, 25 - 65 degree motorized zoom along with it's flat and even make this fixture a good replacement for the traditional fresnels.

Key features:

- 100W power LED
- RGBW color mixing
- Soft and even wash effect
- 25° - 65° motorized zoom
- Smooth dimming, flicker free
- DMX, RDM control
- Dimmer curves selectable
- Silent operation for studio and theatre

Application:

- Theatre, chruch
- Film shooting
- Stage wash

Accessories:

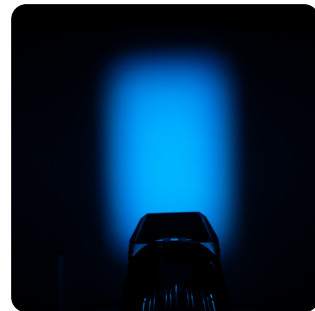
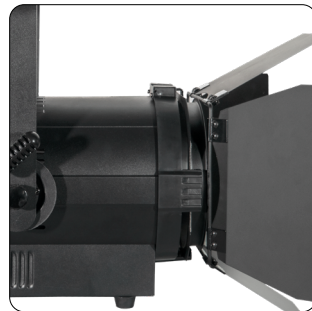
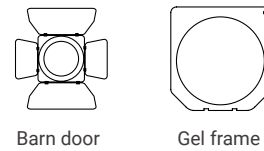

Photometric

R(lx)	2699	378	193	129	98	75	55	42	34
G(lx)	1080	520	273	179	134	112	78	64	51
B(lx)	1289	139	74	48	34	27	18	14	11
W(lx)	1750	812	435	287	199	164	109	82	69
Full on(lx)	3730	780	665	608	433	315	275	199	167

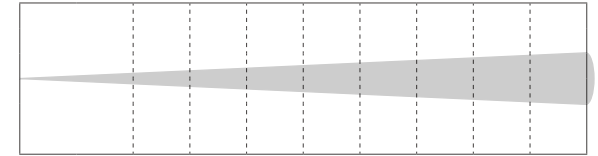

Distance(m)	2	3	4	5	6	7	8	9	10
Spot Diam(m)	0.9	1.3	1.8	2.2	2.7	3.1	3.5	4.0	4.4

Min. Spot - 25° 5600K

R(lx)	120	64	32	26	19	15	10	7	5
G(lx)	175	86	47	36	27	20	13	10	8
B(lx)	48	28	16	12	7	5	4	3	2
W(lx)	274	125	69	57	42	32	17	14	11
Full on(lx)	585	275	156	102	87	66	48	35	27

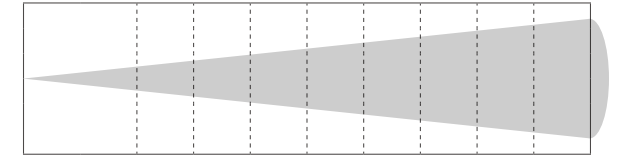

Distance(m)	2	3	4	5	6	7	8	9	10
Spot Diam(m)	2.6	3.9	5.2	6.5	7.8	9.1	10.4	11.7	13

Max. Spot - 65° 5600K

Technical Data

Power supply:	AC100 - 240V, 50/60Hz
Light source:	100W RGBW LED
Color temperature:	3000K ~ 8000K
Zoom range:	25° - 65° motorized zoom
Power connection:	PowerCON in & out
Signal connection:	3-pin XLR in & out(5-pin optional)
Control channels:	ARC.1(3CH), AR1.D(4CH), ARC.2(4CH), AR2.D(5CH), AR2.S(6CH), HSV(3CH), STAG(12CH)
Control mode:	DMX, RDM, Auto
Dimmer speed:	4 grade

Housing:	Colour black, Aluminum
Size:	331 x 210 x 345.7mm
Package(carton):	448 x 338 x 400mm
N.W.:	6.6 kg(barn door incl.)
G.W.:	7.6 kg
Accessories(incl.):	Power cable, barn door, gel frame, safety rope
Accessories(opt.):	Clamp
Compliance:	CE
Environment:	IP20

THEATRICAL LIGHTING

THEATRICAL LIGHTING

3200K/5600K
RDM Control
COB 200W LED
ZOOM
Flicker Free
98 TLCI
96 CRI

The Pioneer 200 Zoom is a 200W 3200K or 5600K powered LED fresnel with zoom function. The RDM-DMX compliant, 15 - 60 degree motorized zoom along with it's superior 96 CRI make this fixture a good replacement for the traditional fresnels.

Key features:

- 200W COB white LED
- 3200K or 5600K color temperature
- CRI 96, R9≥90, TLCI up to 98
- Soft and even wash effect
- 15° - 60° motorized zoom
- Smooth dimming
- Video flicker free
- DMX, RDM control
- Dimmer modes selectable
- Intelligent fan, silent operation

Application:

- Broadcast, HD studio
- Theatre, church
- Film shooting
- Museum
- Exhibition lighting

Accessories:

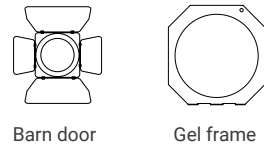

PIONEER 200 ZOOM

WW / CW

200W LED fresnel zoom



Photometric

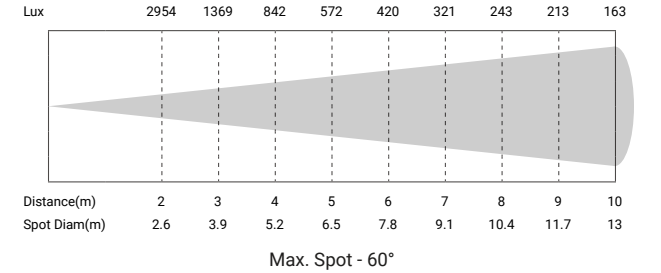
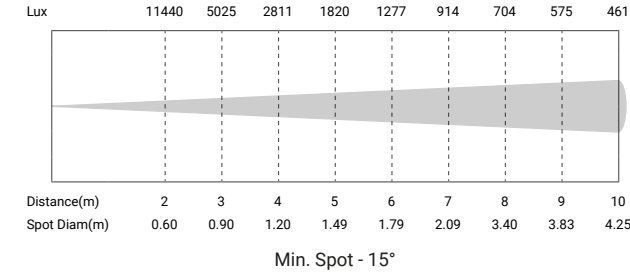

Color Rendition

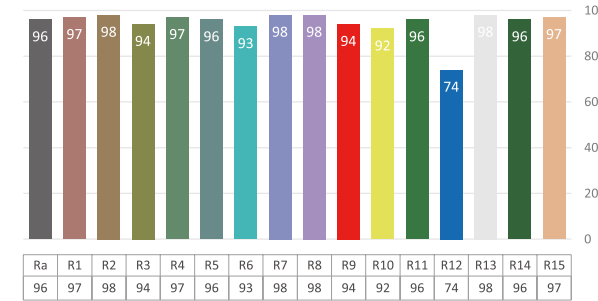

Technical Data

Power supply:	AC100 - 240V, 50/60Hz
Light source:	200W COB LED
Color temperature:	3200K or 5600K
Zoom range:	15° - 60° motorized zoom
Color Rendition:	CRI 96, R9≥90, TLCI 98, CQS 94
Power connection:	PowerCON in & out
Signal connection:	3-pin XLR in & out(5-pin optional)
Control channels:	2/3/4/5
Control mode:	DMX, RDM
Dimmer speed:	4 grade

Housing:	Colour black, Aluminum
Size:	315 x 296 x 330mm
Package(carton):	445 x 352 x 360mm
N.W.:	8 kg(barn door incl.)
G.W.:	9.8 kg
Accessories(incl.):	Power cable, barn door, gel frame, safety rope
Accessories(opt.):	Clamp
Compliance:	CE
Environment:	IP20

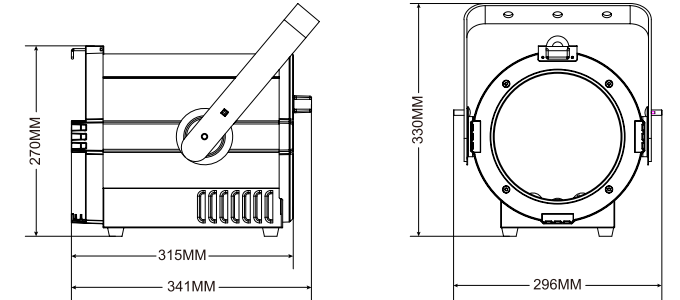

THEATRICAL LIGHTING

THEATRICAL LIGHTING



PIONEER 200C ZOOM

200W RGBW LED fresnel zoom

The Pioneer 200C Zoom is a 200W RGBW powered LED fresnel with zoom function. The RDM-DMX compliant, 15 - 60 degree motorized zoom along with it's superior color mixing make this fixture a good replacement for the traditional fresnels.

Key features:

- 200W LED
- RGBW perfect color mixing
- Soft and even wash effect
- 15° - 60° motorized zoom
- Smooth dimming
- Video flicker free
- DMX, RDM control
- Dimmer modes selectable
- Intelligent fan, silent operation

Application:

- Theatre, church
- Stage wash
- Exhibition lighting

Accessories:

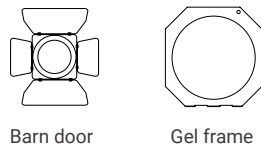

Photometric

R(lx)	852	398	207	137	91	67	49	39	32
G(lx)	1755	764	441	273	192	137	103	76	67
B(lx)	456	176	105	64	44	32	23	14	12
W(lx)	2241	980	564	360	247	183	129	104	82
Full on(lx)	6139	2308	1276	811	565	412	301	241	206

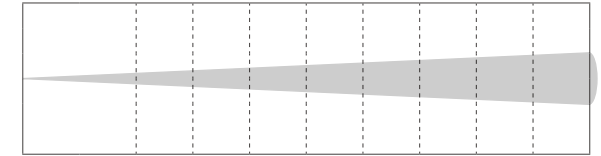

Distance(m)	2	3	4	5	6	7	8	9	10
Spot Diam(m)	0.60	0.90	1.20	1.49	1.79	2.09	3.40	3.83	4.25

Min. Spot - 15°

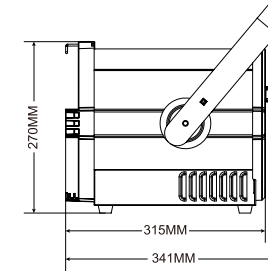

Technical Data

Power supply:	AC100 - 240V, 50/60Hz
Light source:	200W LED
Color mixing:	RGBW
Color temperature:	3000K ~ 8000K
Zoom range:	15° - 60° motorized zoom
Power connection:	PowerCON in & out
Signal connection:	3-pin XLR in & out(5-pin optional)
Control channels:	ARC.1(3CH), AR1.D(4CH), ARC.2(4CH), AR2.D(5CH), AR2.S(6CH), HSV(3CH), STAG(12CH)
Control mode:	DMX, RDM, Auto
Dimmer speed:	4 grade

R(lx)	269	108	62	40	29	21	18	14	10
G(lx)	542	238	132	84	62	46	35	29	22
B(lx)	113	54	30	20	11	7	6	5	4
W(lx)	695	295	172	106	81	56	49	39	33
Full on(lx)	1367	689	395	249	180	167	108	94	76

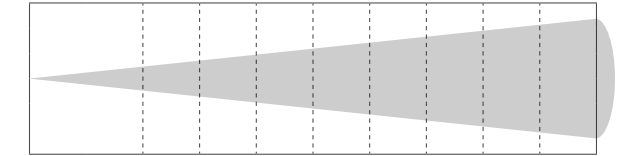

Distance(m)	2	3	4	5	6	7	8	9	10
Spot Diam(m)	2.6	3.9	5.2	6.5	7.8	9.1	10.4	11.7	13

Max. Spot - 60°

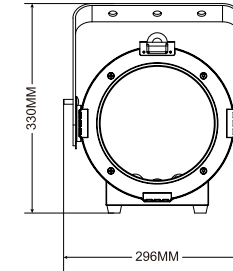

Housing:	Colour black, Aluminum
Size:	315 x 296 x 330mm
Package(carton):	445 x 352 x 360mm
N.W.:	8 kg(barn door incl.)
G.W.:	9.8 kg
Accessories(incl.):	Power cable, barn door, gel frame, safety rope
Accessories(opt.):	Clamp
Compliance:	CE
Environment:	IP20

THEATRICAL LIGHTING

THEATRICAL LIGHTING



The Pioneer 200 PRO is a 200W 3200K or 5600K powered LED fresnel with zoom function. The RDM-DMX compliant, degree motorized zoom along with it's superior 97+ CRI make this fixture a good replacement for the traditional fresnels. *Pioneer 200 Pro is both smaller and brighter than Pioneer 200 Zoom.*

PIONEER 200 PRO

WW / CW

200W LED fresnel zoom



Key features:

- 200W COB white LED
- 30% brighter than the former Pioneer 200
- 3200K or 5600K color temperature
- CRI 97, R9≥90, TLCI up to 98
- Soft and even wash effect
- 10 - 55° motorized zoom
- Smooth dimming
- Dimmer frequency 1.2 - 24.0KHz
- DMX, RDM control
- Dimmer modes selectable
- Intelligent fan, silent operation

Application:

- Broadcast, HD studio
- Theatre, church
- Film shooting
- Museum
- Exhibition lighting

Accessories:



Barn door

Gel frame



Photometric

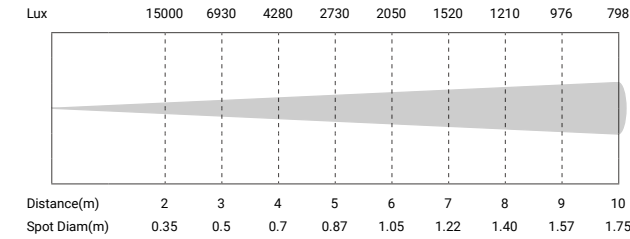

Minimum Spot - 10° 3200K

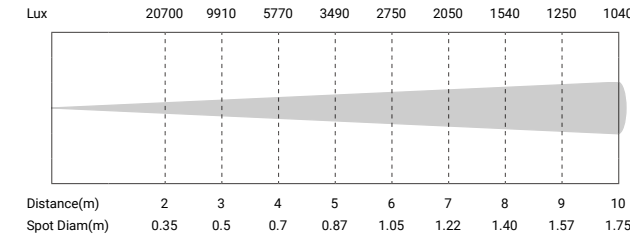

Minimum Spot - 10° 5600K

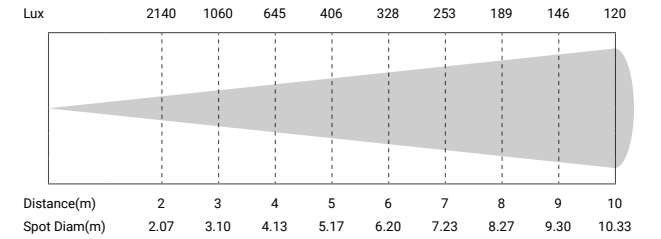

Maximum Spot - 55° 3200K

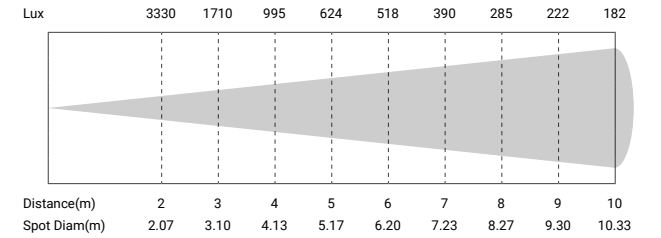

Maximum Spot - 55° 5600K

Technical Data

Power supply:	AC100-240V, 50/60Hz
Light source:	200W COB LED
Color temperature:	3200K or 5600K
Zoom range:	10° - 55° motorized zoom
Color Rendition:	CRI 98, R9≥94, TLCI 98(3200K) CRI 97, R9≥90, TLCI 97(5600K)
Power connection:	PowerCON in & out
Signal connection:	3-pin XLR in&out(5-pin optional)
Control channels:	1/2/3/4
Control mode:	DMX, RDM

Dimmer speed:	4 grade
Housing:	Colour black, Aluminum
Size:	315 x 296 x 330mm
Package(carton):	445 x 352 x 360mm
N.W.:	8 kg(barn door incl.)
G.W.:	9.8 kg
Accessories(incl.):	Power cable, barn door, gel frame, safety rope
Accessories(opt.):	Clamp
Compliance:	CE
Environment:	IP20

2700K - 6500K	RDM Control	175W tunable	ZOOM	Flicker Free	98 TLCI	98 CRI
---------------	-------------	--------------	------	--------------	---------	--------

PIONEER 200T PRO

200W tunable LED fresnel zoom



The Pioneer 200 PRO is a tunable white LED fresnel with zoom function. Color temperature 2700K - 6500K. The RDM-DMX compliant, degree motorized zoom along with it's superior CRI make this fixture a good replacement for the traditional fresnels. *Pioneer 200 Pro is both smaller and brighter than Pioneer 200 Zoom.*

Key features:

- 175Watt WW + 175Watt CW constant output
- 25+% brighter than the former Pioneer 200
- 2700K to 6500K tunable white LED
- Average CRI 98, R9≥90, TLCI up to 98
- Soft and even wash effect
- 10 - 55° motorized zoom
- Smooth dimming
- Dimmer frequency 1.2 - 24.0KHz
- DMX, RDM control
- Dimmer modes selectable
- Intelligent fan, silent operation

Application:

- Broadcast, HD studio
- Theatre, church
- Film shooting
- Museum
- Exhibition lighting

Accessories:



Barn door

Gel frame



Photometric

WW(lx)	9480	4170	2560	1640	1250	953	687	555	458
CW(lx)	13900	6570	3300	2160	1790	1350	1120	730	685
Full on(lx)	11700	5540	3840	2020	1490	1230	934	893	603

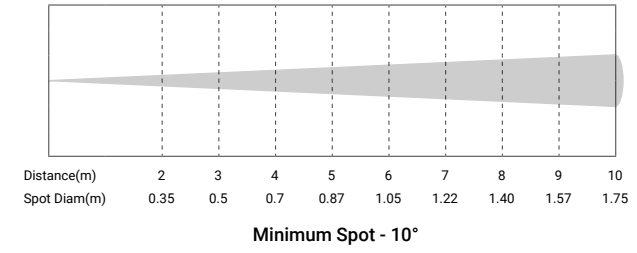

Color Rendition

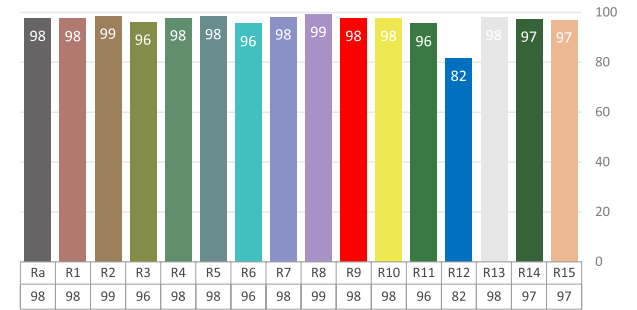

Technical Data

Power supply:	AC100-240V, 50/60Hz
Light source:	175W WW + 175W CW LED
Color temperature:	2700K - 6500K
Zoom range:	10° - 55° motorized zoom
Color Rendition:	CRI 98, R9≥90, TLCI 98(full on 4000K)
Power connection:	PowerCON in & out
Signal connection:	3-pin XLR in&out(5-pin optional)
Control channels:	3/6
Control mode:	DMX, RDM

WW(lx)	1790	879	521	341	276	212	160	134	100
CW(lx)	2590	1280	651	495	386	316	218	177	145
Full on(lx)	2280	1120	757	430	353	254	198	159	127

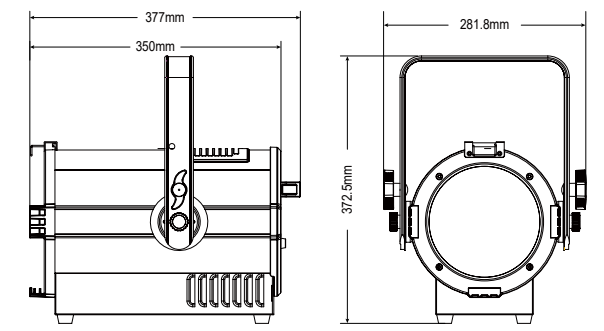
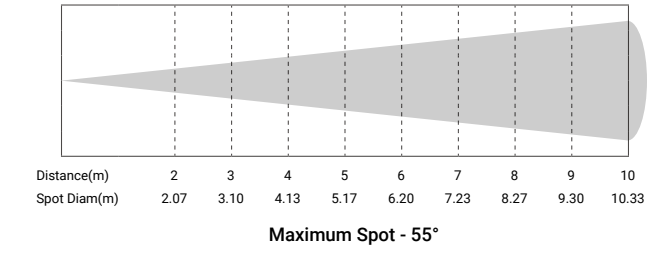

Dimmer speed:	4 grade
Housing:	Colour black, Aluminum
Size:	315 x 296 x 330mm
Package(carton):	445 x 352 x 360mm
N.W.:	8 kg(barn door incl.)
G.W.:	9.8 kg
Accessories(incl.):	Power cable, barn door, gel frame, safety rope
Accessories(opt.):	Clamp
Environment:	IP20

THEATRICAL LIGHTING

THEATRICAL LIGHTING



PIONEER 300 ZOOM

WW / CW

300W LED fresnel zoom

The Pioneer 300 Zoom is a 300W 3200K or 5600K powered LED fresnel. Features motorized zoom range from 8° - 60°. It's high power light output, high CRI, DMX, RDM, soft wash effect make this fixture a perfect replacement of the traditional 1K fresnels.

Key features:

- 300W COB white LED, 3200K or 5600K optional
- 1KW tungsten equivalent
- CRI 97, R9≥90, TLCI 98, CQS 94
- RDM, DMX control
- 4 dimmer curves selectable
- 8° - 60° motorized zoom
- Smooth dimming
- Flicker free with selectable PWM
- Rotary, key, DMX control of dimmer and zoom
- Silent operation for studio and theater use

Application:

- Broadcast, HD studio
- Theatre, church
- Film shooting
- Museum
- Exhibition lighting

Accessories:

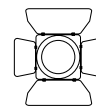

Barn door

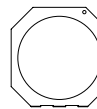

Gel frame



Photometric

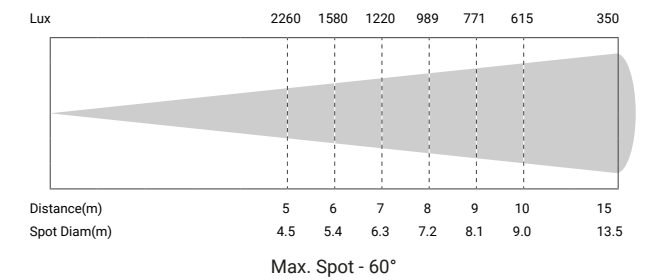
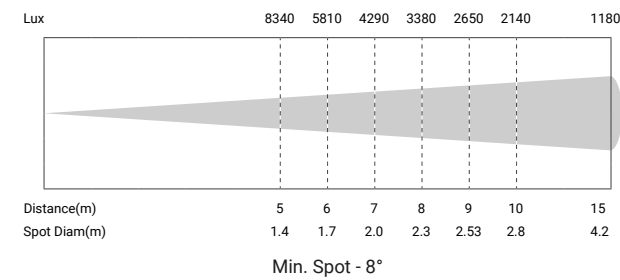

Color Rendition

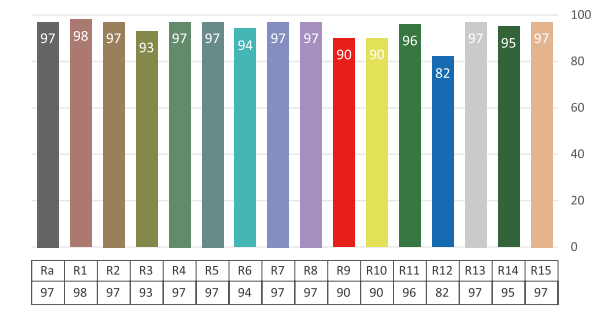

Technical Data

Power supply:	AC100-240V, 50/60Hz
Light source:	300W COB LED
Color temperature:	3200K or 5600K
Zoom range:	8° - 60° motorized zoom
Color Rendition:	CRI 97, R9≥90, TLCI 98, CQS 94
Power connection:	PowerCON in & out
Signal connection:	3-pin & 5-pin XLR in & out
Control channels:	1/2/3/4
Control mode:	Rotary, DMX and RDM
Dimmer curves:	Standard/ Stage/ TV/ Architecture/ Theatre

Housing:	Colour black, Aluminum
Size:	460 x 320 x 440mm
Package(carton):	520 x 360 x 345mm
N.W.:	11 kg(barn door incl.)
G.W.:	13 kg
Accessories(incl.):	Power cable, barn door, gel frame, safety rope
Accessories(opt.):	Clamp
Compliance:	CE
Environment:	IP20

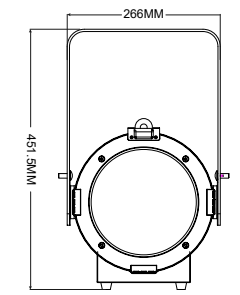
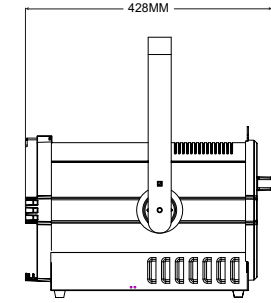

THEATRICAL LIGHTING

THEATRICAL LIGHTING



CTC 300 FRESNEL

300W + 300W tunable LED fresnel zoom

CTC 300 Fresnel is a 300W warm white + 300Watt cold white powered LED fresnel. Features motorized zoom range from 8° - 60°, color temperature 2800K - 6500K tunable. It's high power light output, high CRI, DMX, RDM control, soft wash effect make this fixture a perfect replacement of the traditional 1K fresnels.

Key features:

- 300W warm + 300W cold white LED
- 2800K - 6500K tunable
- 1KW tungsten equivalent
- Average CRI 98, TLCI 98
- RDM, DMX control
- 4 dimmer curves selectable
- Studio mode for super silent operation
- 8° - 60° motorized zoom
- Smooth dimming
- Flicker free with selectable PWM
- Rotary, key, DMX control of dimmer and zoom

Application:

- Broadcast, HD studio
- Theatre, church
- Film shooting
- Museum
- Exhibition lighting

Accessories:

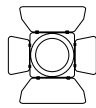

Barn door

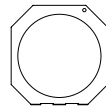

Gel frame



Photometric

WW 2800K(lx)	57400	15300	6600	4100	2660	1900	1400	1050	850	700
CW 6500K(lx)	74700	20000	9400	5500	3600	2500	1900	1400	1100	950
Full on 4000k(lx)	74100	20200	9500	5540	3600	2500	1900	1400	1100	950

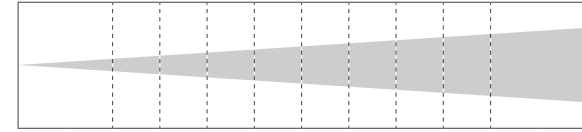

Distance(m)	1	2	3	4	5	6	7	8	9	10
Spot Diam(m)	0.3	0.6	0.8	1.1	1.4	1.7	2.0	2.3	2.53	2.8

Min. Spot

WW 2800K(lx)	18000	3900	1850	1100	800	600	480	360	290	255
CW 6500K(lx)	18200	5300	2500	1500	1060	800	630	500	400	340
Full on 4000k(lx)	18500	5300	2540	1550	1080	800	630	500	400	340

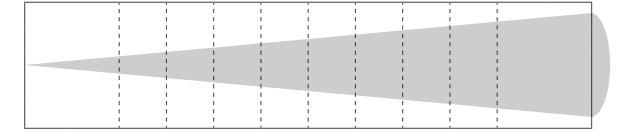

Distance(m)	1	2	3	4	5	6	7	8	9	10
Spot Diam(m)	0.9	1.8	2.7	3.6	4.5	5.4	6.3	7.2	8.1	9.0

Max. Spot

Color Rendition | 4000K

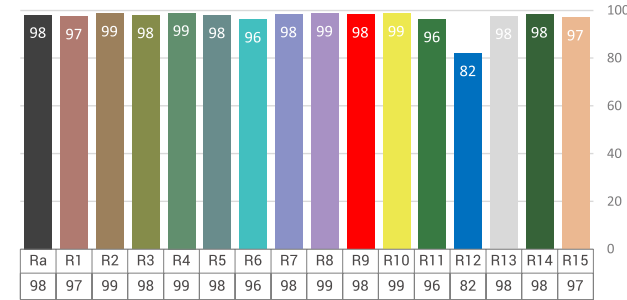

Technical Data

Power supply:	AC100-240V, 50/60Hz
Light source:	300W WW + 300W CW LED
Color temperature:	2800K - 6500K tunable
Zoom range:	8° - 60° motorized zoom
Color Rendition:	CRI 98, R9≥98, TLCI 98
Power connection:	PowerCON in & out
Signal connection:	3-pin & 5-pin XLR in & out
Control channels:	3/6
Control mode:	Rotary, DMX and RDM

Dimmer curves:	Standard/ Stage/ TV/ Architecture/ Theatre/Studio
Housing:	Colour black, Aluminum
Size:	460 x 320 x 440mm
Package(carton):	520 x 360 x 345mm
N.W.:	11 kg(barn door incl.)
G.W.:	13 kg
Accessories(incl.):	Power cable, barn door, gel frame, safety rope
Accessories(opt.):	Clamp
Environment:	IP20

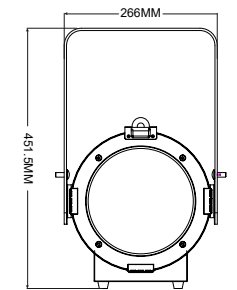
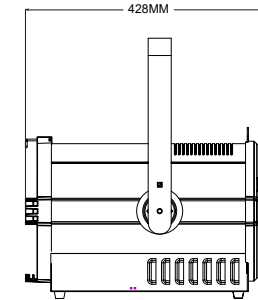

THEATRICAL LIGHTING

THEATRICAL LIGHTING



PIONEER 350C ZOOM

350W RGBALC color LED fresnel zoom

The Pioneer 350C Zoom is a 350W RGBALC powered LED fresnel with zoom function. The RDM-DMX compliant, 20 - 55 degree motorized zoom along with it's superior color mixing make this fixture a good replacement for the traditional fresnels.

Key features:

- 350W LED
- RGBALC six color mixing
- Soft and even wash effect
- High CRI of 95
- 20 - 55° motorized zoom
- Video flicker free
- DMX, RDM control
- 3-pin + 5-pin DMX in & out
- Dimmer modes selectable
- Intelligent temperature control

Application:

- Theatre, church
- Film shooting
- Museum
- Stage wash

Accessories:

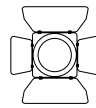

Barn door

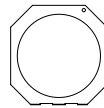

Gel frame



Photometric

R(lx)	256	187	141	105	92	75
G(lx)	434	334	246	193	155	126
B(lx)	124	97	70	55	45	36
A(lx)	905	676	513	396	326	263
L(lx)	1430	1050	811	633	513	415
C(lx)	278	217	157	124	97	81
Full on(lx)	3220	2420	1800	1400	1120	925

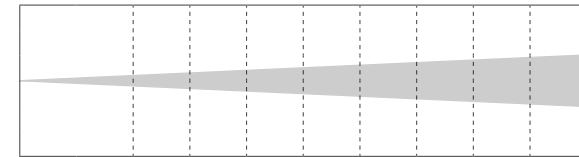

Distance(m)	5	6	7	8	9	10
Spot Diam(m)	1.49	1.79	2.09	3.40	3.83	4.25

Min. Spot - 20°

R(lx)	31	26	21	17	13.5	11
G(lx)	56	43	33	27	21	17
B(lx)	16	12	10	8	6	5
A(lx)	121	94	71	59	47	37
L(lx)	189	142	110	89	73	59
C(lx)	36	28	22	19	14	11
Full on(lx)	412	334	254	202	163	126

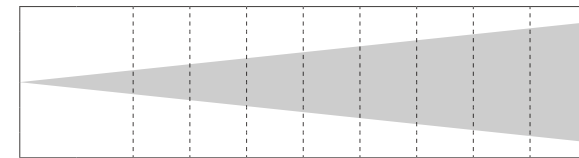

Distance(m)	5	6	7	8	9	10
Spot Diam(m)	6.5	7.8	9.1	10.4	11.7	13

Max. Spot - 55°

Color Temperature Channel-CRI

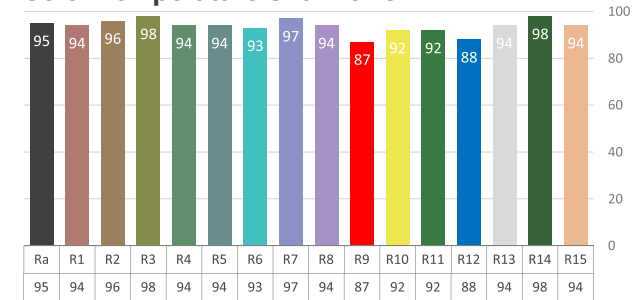

Technical Data

Power supply:	AC100-240V, 50/60Hz
Light source:	350W COB LED
Color temperature:	3000K ~ 8000K
Zoom range:	20° - 55° motorized zoom
Color Rendition:	CRI≥95(CT channel), CRI 85(full on avg)
Power connection:	PowerCON in & out
Signal connection:	3-pin XLR in & out, 5-pin XLR in & out
Control channels:	2/8/13
Control mode:	Rotary, DMX, RDM, Auto
Dimmer mode:	Standard/ Stage/ TV/ Architecture/ Theatre/ Custom
Fan mode:	Studio mode for silent operation
Housing:	Colour black, Aluminum
Size:	460 x 320 x 440mm
Package(carton):	520 x 360 x 345mm
N.W.:	11 kg(barn door incl.)
G.W.:	13 kg
Accessories(incl.):	Power cable, barn door, gel frame, safety rope
Accessories(opt.):	Clamp
Compliance:	CE
Environment:	IP20



ATMOS 100T

100W tunable LED house light



Atmos 100T is a 100Watt WW + 100W CW tunable white LED house light. It comes with fan-free design, and project uniform field of light. Color temperature 2700K - 6900K adjustable at 100 watt constant output. The fixture also brings high CRI , TLCI .

Key features:

- 100Watt + 100Watt tunable white LED
- CCT 2700K - 6900K tunable
- High brightness, uniform coverage
- Fan-free design, silent operation for all circumstances
- High CRI 96, TLCI 98
- Dimmer curves selectable
- Smooth dimming, flicker free operation
- Dimmer frequency 1.2 - 20.0 KHz
- Beam angle 35°, field angle 60°
- Ideal for fixed installation
- Yoke possible to mount on side of fixture

Application:

- Theatres
- House of worship
- Concert hall



Photometric

WW - 2700K	9190	2400	1770	650	448
CW - 6900K	12900	3230	1480	844	763
Full on -4000K	16400	3980	1780	1020	660

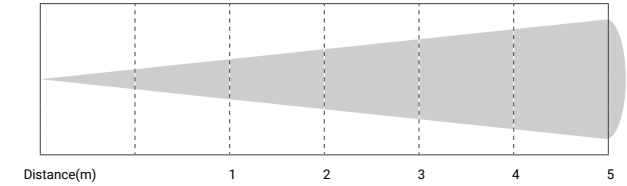

Color Rendition - 4000K

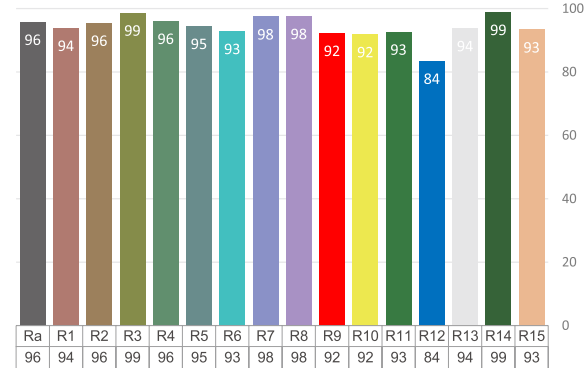

Technical Data

Power supply:	AC100 - 240V, 50/60Hz
Power consumption:	100Watt Max.
Light source:	100Watt WW + 100Watt CW LED
Beam angle:	35°(field angle: 60°)
Color temperature:	2700K - 6900K(±200K)
Color Rendition:	Avg. CRI 96, TLCI 98, TM-30 Rf 94, TM-30 Rg 101
Power connection:	PowerCON in
Signal connection:.	3-pin XLR in & out
Control channels:	1/2/3/5

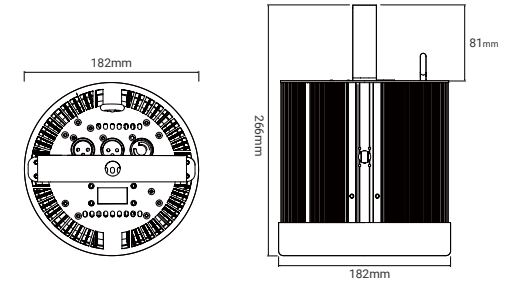

Spectral distribution - 4000K

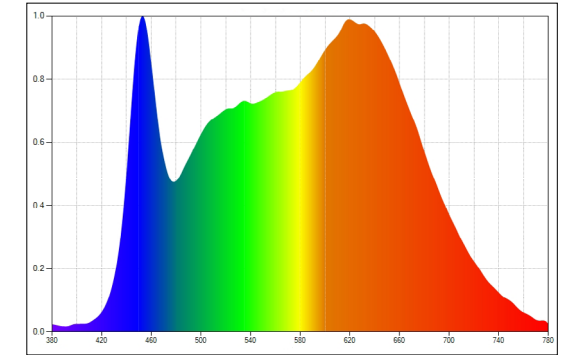

Control mode:	DMX, RDM
Dimmer curves:	Standard / Stage / TV / Archi / Theatre/ Studio/
Frequency:	1.2 KHz, 1.6 KHz, 2.4 KHz, 4 KHz, 6 KHz, 20 KHz
Housing:	Colour black, Aluminum
Size:	182 x 182 x 266mm
N.W.:	3.7 kg
Accessories(incl.):	Power cable, Safety cable
Accessories(opt.):	Clamp
Environment:	IP20



PAR MASTER X1

WW / CW

150W LED zoom par

Powered by 150W 3200K or 5600K LED, the Par Master X1 is designed to replace the traditional lamp 1000W halogen par64. Featuring manual zoom range from 25°-80°, 96 CRI and R9 up to 94, durable LED life, compact design. It creates a flat and even field of light.

Key features:

- 150W COB white LED
- 3200K or 5600K color temperature selectable
- Manually zoom, range from 25°-80°
- High CRI 96, R9 up to 94
- TLCI up to 98
- DMX-RDM compliant
- Video flicker free
- Equal to S4 HPL750 par

Application:

- Theatre, church
- Film shooting
- Museum
- Exhibition lighting

Accessories:

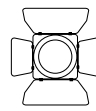

Barn door

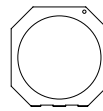

Gel frame



Photometric

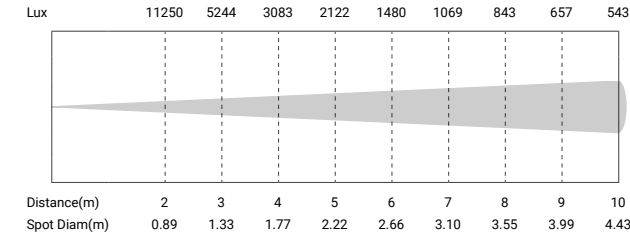

Min. Spot - 25° 5600K

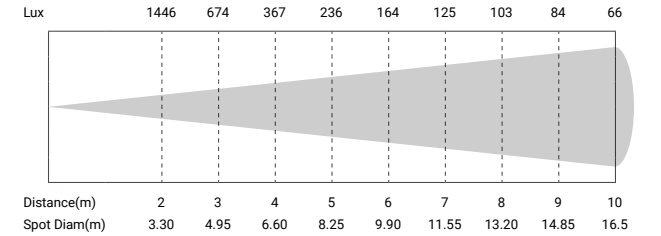

Max. Spot - 80° 5600K

Color Rendition

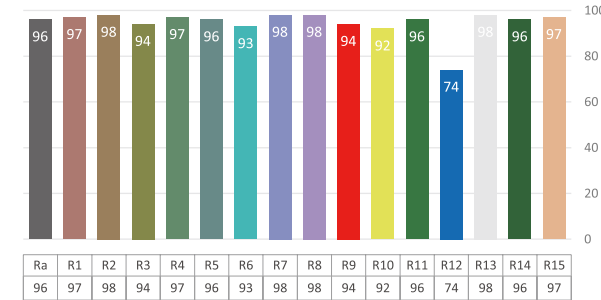

Technical Data

Power supply:	AC100 - 240V, 50/60Hz
Light source:	150W COB LED
Color temperature:	3200K or 5600K
Zoom range:	25° - 80° manual zoom
Color Rendition:	CRI 96, R9≥90, TLCI 98, CQS 94
Power connection:	IP power cable in & out
Signal connection:	3-pin XLR in & out(5-pin optional)
Control channels:	1/2/3/4
Control mode:	DMX, RDM

Dimmer speed:	4 grade
Housing:	Colour black, Aluminum
Size:	290 x 260 x 305mm
Package(carton):	290 x 290 x 350mm
N.W.:	5 kg(barn door incl.)
G.W.:	5.6 kg
Accessories(incl.):	Power cable, barn door, Gel frame
Accessories(opt.):	Clamp, Safety rope
Environment:	IP20

THEATRICAL LIGHTING

THEATRICAL LIGHTING



PAR MASTER C1

150W LED RGBW zoom par

Powered by 150W RGBW LED, the Par Master C1 is designed to replace the traditional lamp par. Featuring manual zoom range from 25°-80°, durable LED life, compact design, flat and even field of light.

Key features:

- 150W LED
- RGBW color mixing
- Flat and even color mixing
- Manually zoom, range from 25°-80°
- DMX-RDM compliant
- Video flicker free
- Four leaf rotatable barn door

Application:

- Theatre, church
- Stage wash
- Wedding
- Exhibition lighting

Accessories:

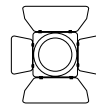

Barn door

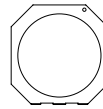

Gel frame



Photometric

R(lx)	1190	476	302	189	127	93	83	59	55
G(lx)	1920	856	526	331	228	169	139	114	93
B(lx)	487	239	143	87	62	46	37	29	27
W(lx)	2750	1230	752	473	329	244	195	159	127
Full on(lx)	6230	2780	1670	1050	699	526	438	334	289

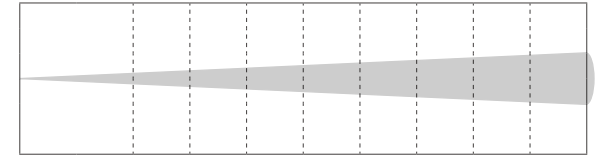

Distance(m)	2	3	4	5	6	7	8	9	10
Spot Diam(m)	0.89	1.33	1.77	2.22	2.66	3.10	3.55	3.99	4.43

Min. Spot - 25°

R(lx)	142	79	69	58	25	16	12	9	7
G(lx)	254	134	126	87	38	27	19	16	13
B(lx)	68	36	33	27	19	13	8	7	5
W(lx)	372	189	169	121	56	39	36	25	19
Full on(lx)	765	395	365	270	112	86	66	57	39

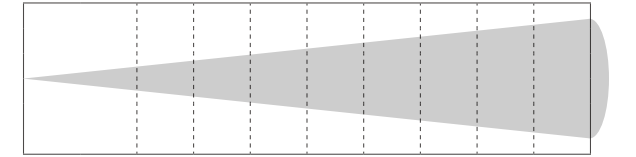

Distance(m)	2	3	4	5	6	7	8	9	10
Spot Diam(m)	3.30	4.95	6.60	8.25	9.90	11.55	13.20	14.85	16.5

Max. Spot - 80°

Technical Data

Power supply:	AC100 - 240V, 50/60Hz
Light source:	150W RGBW LED
Color mixing:	RGBW
Color temperature:	3000K~8000K
Zoom range:	25°- 80° manual zoom
Power connection:	IP power cable in & out
Signal connection:	3-pin XLR in & out(5-pin optional)
Control channels:	ARC.1(3CH), AR1.D(4CH), ARC.2(4CH), AR2.D(5CH), AR2.S(6CH), HSV(3CH), STAG(11CH)
Control mode:	DMX, RDM, Auto

Dimmer speed:	4 grade
Housing:	Colour black, Aluminum
Size:	290 x 260 x 305mm
Package(carton):	290 x 290 x 350mm
N.W.:	5 kg(barn door incl.)
G.W.:	5.6 kg
Accessories(incl.):	Power cable, barn door, gel frame
Accessories(opt.):	Clamp, safety rope
Environment:	IP20

THEATRICAL LIGHTING

THEATRICAL LIGHTING



POWER PAR 350

WW / CW

The Power par 350 series is powered by 31x10W LED. With warm white, pure white or tunable LEDs selectable. Features extremely high brightness and compact body. It's high power light output, even wash effect make this fixture a perfect replacement of the traditional 575W power par.

Key features:

- 31x10W LED
- WW, CW, tunable white optional
- Super bright
- Long distance throw
- Various LED color selectable
- Video flicker free
- HQ LEDs, long life time
- Die-cast aluminum body
- PowerCon in & out connection

Application:

- Auto exhibition
- Large event
- Stadium
- Shopping mall
- Display lighting

Accessories:



Barn door



Diffusion(opt.)



Photometric

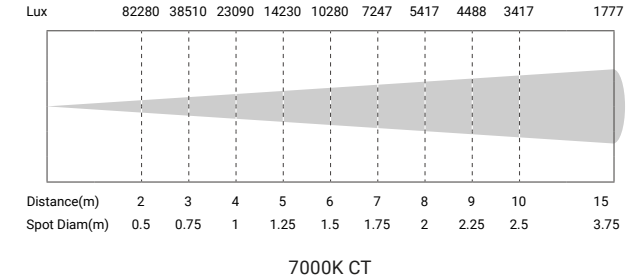

Technical Data

Power supply:	AC100 - 240V, 50/60Hz
Light source:	31 x 10W LED
Color temperature:	2700K/7000K/tunable white
Beam angle:	25°
Power connection:	PowerCON in & out
Signal connection:	3-pin XLR in & out(5-pin optional)
Control channels:	2
Control mode:	DMX 512
Housing:	Color black, aluminum

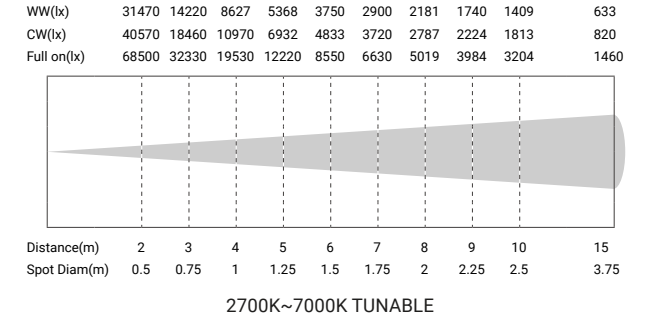

Size:	507 x 269 x 269mm
Package(carton):	320 x 320 x 570mm
N.W.:	7.4 kg(barn door incl.)
G.W.:	10 kg
Accessories(incl.):	Power cable, barn door, safety rope
Accessories(opt.):	Diffusion lens, clamp
Compliance:	CE
Environment:	IP20

Size

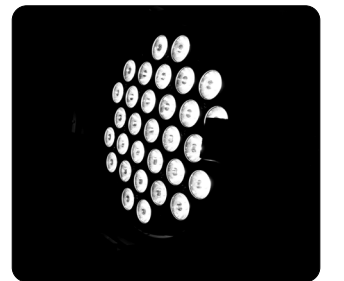
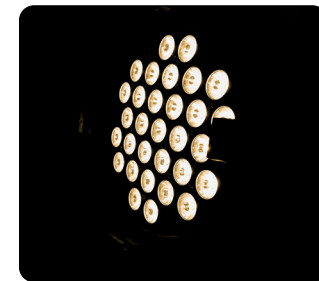
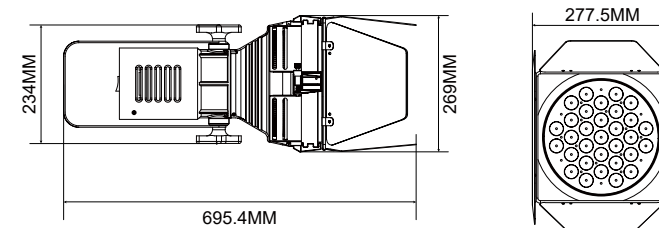

THEATRICAL LIGHTING

THEATRICAL LIGHTING



Key features:

- 4 x 100W LED, high brightness
- Individual control of each LED
- 3200K ~ 5600K tunable, single white optional
- Smooth dimming, flicker free
- Aluminum housing

BLINDER 400

4 eye blinder

Technical Data

Power supply:	AC100 - 240V, 50/60Hz
Light source:	4 x 100W LED
Color temperature:	3200K ~ 5600K, single white optional
Beam angle:	60°
Power connection:	PowerCON in & out
Signal connection:	3-pin XLR in & out
Control channels:	2/6/12
Control mode:	DMX 512
Housing:	Colour black, Aluminum
Package(carton):	430 x 270 x 420mm
N.W.:	8.5 kg
Accessories:	Power cable
Environment:	IP20



- 93 CRI
- Flicker Free
- 3200K/5600K
- RGB LED

PANEL 200

200W LED panel

Key features:

- 490 x 0.5W high brightness SMD LED
- Color temp 3200K/5600K optional
- High CRI of 93 Ra
- 120° beam angle
- Aluminum housing, silent operation

Technical Data

Power supply:	AC100 - 240V, 50/60Hz
Light source:	490 x 0.5W SMD LED
Color temperature:	3200K/5600K optional
Beam angle:	120°
Power connection:	PowerCON in & out
Signal connection:	3-pin XLR in & out
Control channels:	1/2
Control mode:	DMX 512
Housing:	Colour black, Aluminum
Size:	480 x 270 x 127mm
Package:	505 x 200 x 125mm
N.W.:	8.5 kg
G.W.:	9.5 kg
Accessories:	Power cable, barn door
Environment:	IP20



- STROBE
- SMD LED
- DMX 512
- RGB LED

STROBE 1000 RGB

200W LED strobe

Key features:

- 200W RGBW LED strobe
- 1000 pcs SMD LED
- Even color mixing, bright
- Strobe, Blinder, Wash all in one
- Aluminum housing
- Segment control

Technical Data

Power supply:	AC100 - 240V, 50/60Hz
Light source:	1000 x 0.3W SMD LED
Power consum.	230W
Color mixing:	RGB 3in1
Color temperature:	6500K~7500K
Power connection:	PowerCON in & out
Signal connection:	3-pin XLR in & out
Control channels:	8
Control mode:	DMX 512, Sound, Auto
Housing:	Colour black, Aluminum
Size:	540 x 275 x 140mm
Package:	540 x 320 x 205mm
N.W.:	7.5 kg
G.W.:	8 kg
Accessories:	Power cable
Environment:	IP20

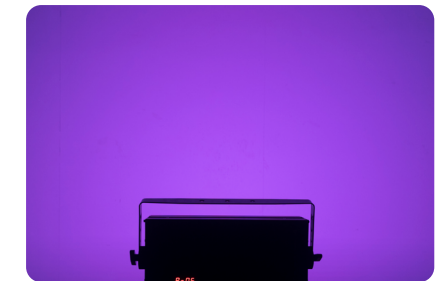
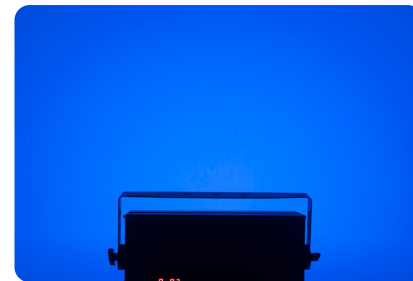

THEATRICAL LIGHTING

THEATRICAL LIGHTING



The RDM DMX RC1 is a palm sized RDM/DMX controller. It can monitor and control DMX units compliant with RDM. DMX addresses can be detected and set remotely. It features compact and modern design, battery powered, touch screen and SD card available for storage of chases and scenes.

Key features:

- RDM Compliant
- Monitor and control and RDM devices
- Detect and set DMX address remotely
- SD card for storage chases and scenes and firmware update
- Battery powered, 8-hours' operation
- Charged via 5V 2A Micro-USB charger
- 5 inch capacitive touchscreen

RDM DMX RC1

DMX/RDM controller

Technical Data

Power supply:	5V via charger at 100-240 V AC, 50/60 Hz
Power connection:	Micro USB
DMX512/RDM:	3-pin and 5-pin XLR in & out
Display:	5" 480x854 IPS capacitive touchscreen
Battery pack type:	Li-ion 3.7V 2000mAh 7.4Wh x 2
Battery life:	8 hrs
Control protocol:	DMX, RDM
Housing:	Colour black, Plastic cover, Steel base
Size:	170 x 113 x 48mm
N.W.:	0.6kg
Environment:	IP20

Size

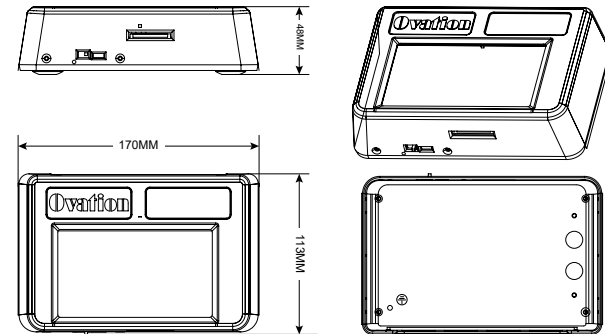

Key features:

- RDM Compliant
- Multi-voltage auto-switching power supply
- 2 XLR (3-pin) for DMX input
- 8 optically isolated XLR plugs (3-pin) for DMX output
- LED indication for functions
- 1 x IEC in port
- Rack or truss mount possible



Key features:

- Distributes Art-Net data to 8 DMX512 universes (4096 channels)
- 8 optically isolated XLR plugs (3-pin) for DMX output
- 2 XLR (3-pin) for DMX input
- Variable data routing capabilities for all DMX outputs
- Serial connection possible
- User-friendly configuration directly at the front panel via 4 operating buttons and alphanumeric LCD screen (2 x 16 characters)
- LED indication for functions
- DMX Splitter / DMX booster operation possible

RDM DMX SP8

8 way DMX/RDM splitter

Technical Data

Power supply:	110-240 V AC, 50/60 Hz
Power connection:	PowerCON in & out
Signal inputs:	2 x 3-pin XLR male
Signal outputs:	8 x 3-pin XLR female
Control connection:	RDM, DMX pass-thru
Housing:	Colour black, Steel
Size:	483 x 145 x 44.4mm
N.W.:	1.7 kg
Environment:	IP20

ARTNET DMX AD8

8 way Ethernet-to-DMX splitter

Technical Data

Power supply:	110-240 V AC, 50/60 Hz
Power connection:	PowerCON in
Power consumption:	15W
DMX512 inputs:	2 x 3-pin XLR male
DMX512 outputs	8 x 3-pin XLR female
Ethernet:	2 x RJ45 100 Mbps
Protocol:	Art-Net 4
Housing:	Colour black, Steel
Size:	483 x 169 x 44.4mm
N.W.:	2.9 kg
Environment:	IP20



An ISO 9001:2015 Co.



Our trademarks:

Hotion **Ovation** **iFROG**

Guangzhou Hotion Technology Co., Ltd

1st Floor, Building 29, Meidong Industrial Park,
Huadu District, Guangzhou, China (510880)

T: +86 020-86847336

E: info@hotion.com

www.hotion.com

Manufacture of:

- Studio Lighting
- Professional Lighting
- Entertainment Lighting
- Architectural Lighting



Download latest catalog

Follow us on:



Instagram
@ovationlight



Twitter
@ovationlight



Facebook
@ovationlighting



Youtube

© Copyright by Hotion 078/2022. All rights reserved.
All specifications are subject to change without prior notice

rev22_12_X