

**Ovation**<sup>®</sup>  
-by **Hotion**



[hotion.com](http://hotion.com)

**PRODUCT CATALOGUE**

**THEATRICAL & STUDIO**



Factory



Motorized Production Line

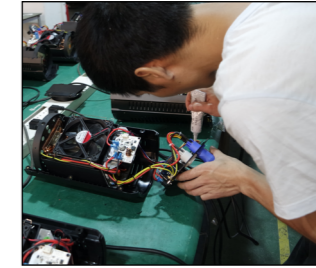

Glue connectors



Aging Test



Temp & Humi Test Machine



Safety test

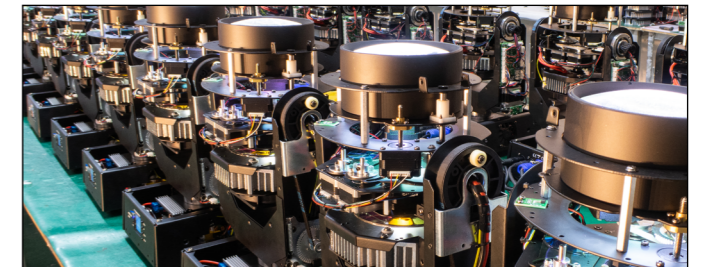

Mass production



QC Check

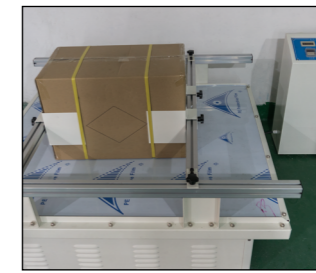

Transportation Test



Loading Container

COB  
300W LED

ZOOM

Flicker Free

98  
TLCI97  
CRIAUTO  
Pan/Tilt/Zoom**WARRIOR 300**

300W LED MH framing profile

**Technical Data**

Power supply:	AC100-240V, 50/60Hz
Light source:	300W COB LED
Color Rendition:	CRI 97, R9≥90, TLCI 98, CQS 94
Zoom range:	5° - 50° motorized zoom
Pan:	540°
Tilt:	270°
Power connection:	PowerCON in
Signal connection:	3-pin XLR in&out
Control mode:	DMX 512
Housing:	Colour black, Aluminum, Plastic
Size:	380 x 290 x 704mm
N.W.:	20 kg
Accessories:	Power cable, omega bracket, Safety rope(optional)
Environment:	IP20

**Key features:**

- 300W COB LED, high output
- CRI 97 Ra, R9>90, TLCI 98, CQS 94
- Pan & tilt, accurate positioning
- Motorized focus
- Auto framing, rotatable

**New**COB  
200W LED

Flicker Free

95  
CRI**REBORN 200**

S4 profile LED engine

**New****Key features:**

- 100~240V auto ranging
- S4 575W profile upgrade engine
- 200W high brightness LED
- Tool-free upgrade
- High CRI of 95
- Smooth dimming, flicker free
- LED life 20,000 hours
- PowerCon in connection

**Technical Data**

Power supply:	AC100-240V, 50/60Hz
Light source:	200W LED
Color temperature:	3200K
Color Rendition:	CRI 95 Ra
Power connection:	PowerCON in
Signal connection:	3-pin XLR in&out(5-pin optional)
Control mode:	DMX 512
Housing:	Color black, die-casting aluminum
Size:	195 x 145 x 160mm
N.W.:	4 kg
Accessories:	Power cable
Environment:	IP20





# KNIGHT 300

WW / CW

300W LED MH fresnel zoom



The Knight 300 is a 300W LED fresnel with motorized controlled of pan, tilt and zoom. A high efficient, labor-saving, revolutionary innovation in theatre lighting industry.

### Key features:

- 300W white LED
- 3200K or 5600K color temperature
- CRI 97, R9≥90, TLCI up to 98
- Auto positioning, high efficient, labor-saving
- 25-80° motorized zoom
- 16 bit dimming via DMX
- Video flicker free
- DMX control
- Intelligent temperature control

### Application:

- Theatre, church
- Event, venues
- Museum
- Stage
- Exhibition lighting



### Photometric

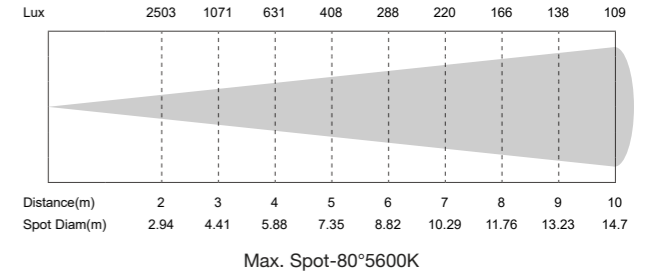
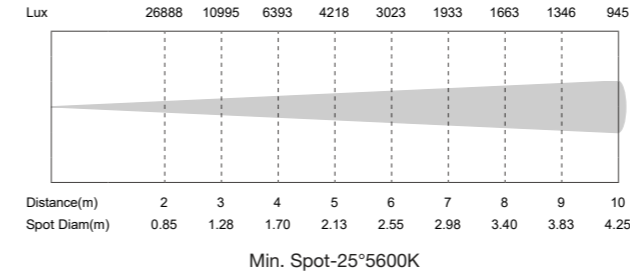

### Color Rendition

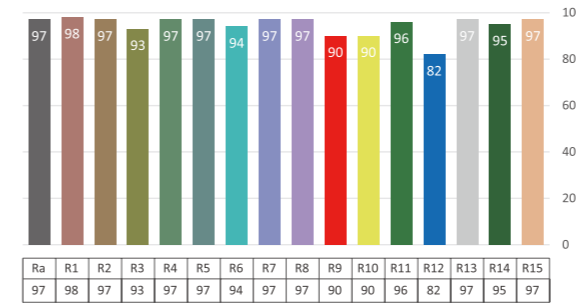

### Technical Data

Power supply:	AC100-240V, 50/60Hz
Light source:	300W COB LED
Color temperature:	3200K or 5600K
Pan:	540°
Tilt:	270°
Zoom range:	25°- 80° motorized zoom
Color Rendition:	CRI 97, R9≥90, TLCI 98, CQS 94
Power connection:	PowerCON in
Signal connection:	3-pin XLR in&out

Control channels:	9
Control mode:	DMX, master-slave
Housing:	Colour black, Aluminum
Size:	610 x 380 x 290mm
N.W.:	15.4 kg
Accessories(incl.):	Power cable, safety rope, gel frame, omega bracket
Accessories(opt.):	Clamp
Environment:	IP20



Mini Leko 20 is a tiny 20W COB LED profile spot. Die-casting housing, fan-free design. With 19°, 26°, 36°, 50° lens optional, and portable, track mount version selectable. It's an idea product for art gallery, Museum, Shopping mall.

**Key features:**

- 20W COB LED, high lumen
- 3200K or 5600K color temp
- High CRI of 92
- Die-casting aluminum housing, fan-free
- 19°, 26°, 36°, 50° lens selectable
- Smooth dimming, flicker free
- Compact body, easy to set up
- Track mount version selectable
- Fresnel version selectable

**Application:**

- Museum
- Theatre, church
- Shopping mall
- Art gallery
- Restaurant

**Accessories:**

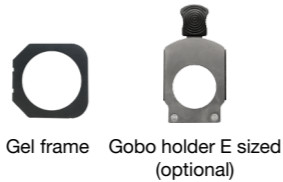

Gel frame Gobo holder E sized (optional)

# MINI LEKO 20

WW / CW

20W LED profile spot



\*Fresnel version-Piospot 20\*



\* Track mount version available\*

**Photometric**

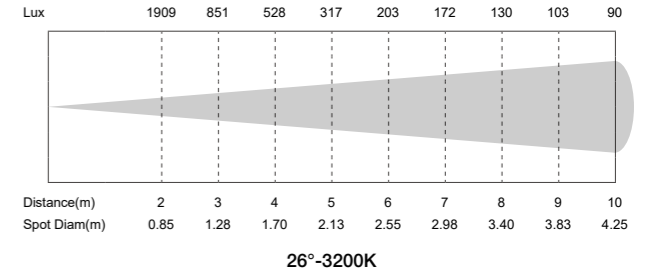
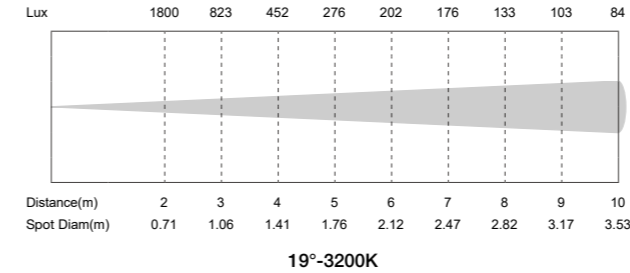

**Color Rendition**

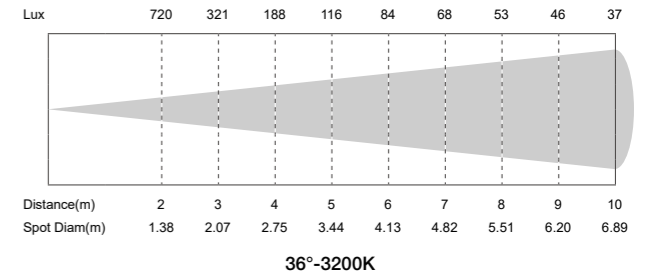
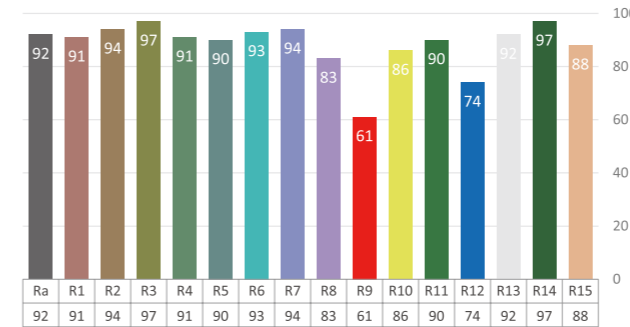

**Technical Data**

Power supply:	AC100-240V, 50/60Hz
Light source:	20W COB LED
Color temperature:	3200K or 5600K
Fixed lens:	19°, 26°, 36°, 50° optional
Color Rendition:	CRI 92
Power connection:	Dedicated power in
Signal connection:	3-pin XLR in&out
Control channels	1/3

Control mode:	DMX, track mount version optional
Housing:	Color black, die-casting aluminum
Size:	343.7 x 133 x 131mm
N.W.:	1.5 kg
Accessories(incl.):	Power cable, gel frame
Accessories(opt.):	Gobo holder E sized, Clamp, Safety rope
Environment:	IP20



Mini Profile 40Z is a mini 40W COB LED profile spot. Die-casting housing, fan-free design. With 19~32°, 25~50° zoom lens optional, and portable, track mount version selectable. It's an idea product for art gallery, museum, shopping mall.

**Key features:**

- 40W COB LED
- 3200K or 5600K color temp
- High CRI of 92
- Die-casting aluminum housing, fan-free
- 19-32° or 25-50° zoom lens
- Smooth dimming, flicker free
- Compact body, easy to set up
- Rotary, DMX control of dimmer(portable ver.)
- RDM function available
- Track mount version selectable

**Application:**

- Museum
- Theatre, church
- Shopping mall
- Art gallery
- Restaurant

**Accessories:**



# MINI PROFILE 40Z

WW / CW

40W LED profile zoom

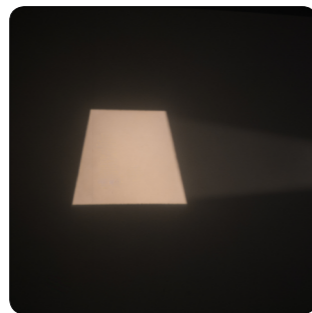

\*track mount version (no DMX)



\*track mount version optional( with DMX)

**Photometric**

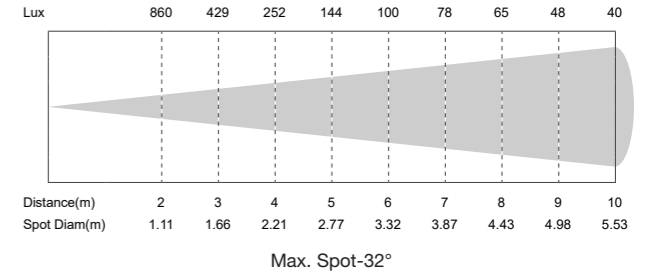
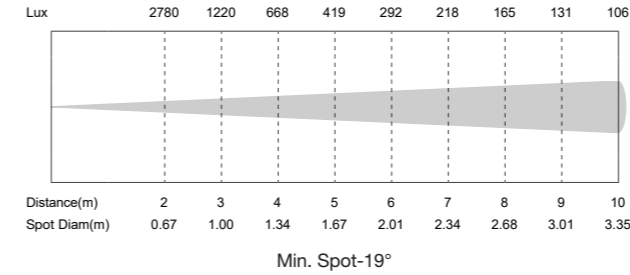

**Color Rendition**

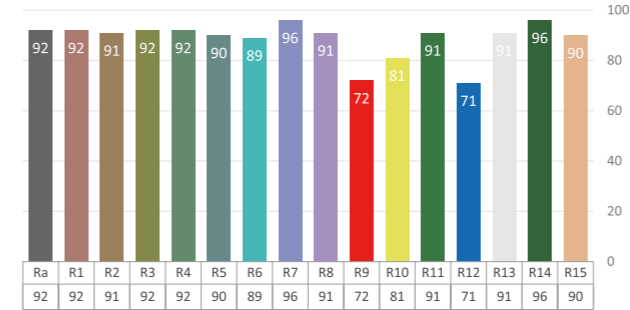

**Technical Data**

Power supply:	AC100-240V, 50/60Hz	Control mode:	Rotary, DMX, RDM
Light source:	40W COB LED	Housing:	Color black, die-casting aluminum
Color temperature:	3200K or 5600K	Size:	402 x 180 x 230mm
Zoom range:	19°- 32° , 25°-50° optional	N.W.:	2.3 kg
Color Rendition:	CRI 92	G.W.:	3 kg
Power connection:	Dedicated power in	Accessories(incl.):	Power cable, gel frame
Signal connection:	3-pin XLR in&out(5-pin optional)	Accessories(opt.):	Gobo holder, Clamp, Safety rope
Control channels:	1/2/3/4	Environment:	IP20

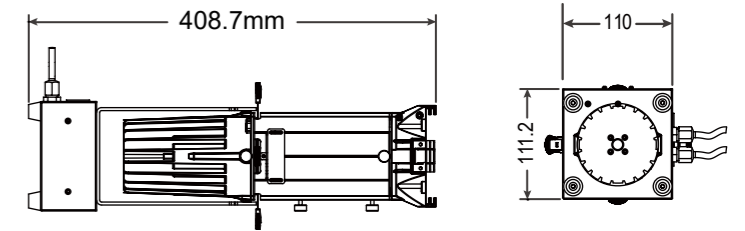

THEATRICAL LIGHTING

THEATRICAL LIGHTING

3200K/5600K
RDM Control
COB 300W LED
ZOOM
Flicker Free
98 TLCI
97 CRI
ArNet Optional

# HONOR 300 ZOOM

WW / CW

300W LED profile zoom

Powered by 300W 3200K or 5600K LED, the Honor 300 Zoom is designed to replace the 1K Tungsten Halogen profile light. The 18-38° “all-in-one” zoom range covers the most regular 19°, 26°, 36° lens. It creates a flat and even field of light and crisp pattern projection.

### Key features:

- 300W COB white LED
- CRI 97, R9≥90, TLCI up to 98
- HD optical system, clean shutter cuts beam
- 18-38° "all-in-one" zoom range
- 16 bit dimming via DMX
- Flicker free with selectable PWM
- Rotary, key, DMX control of dimmer
- Silent operation for studio and theatre use
- Arnet version optional
- Engine and lens compatible with industry standard

### Application:

- Broadcast, HD studio
- Theatre, church
- Fashion show
- Museum
- Exhibition lighting

### Accessories:



### Photometric

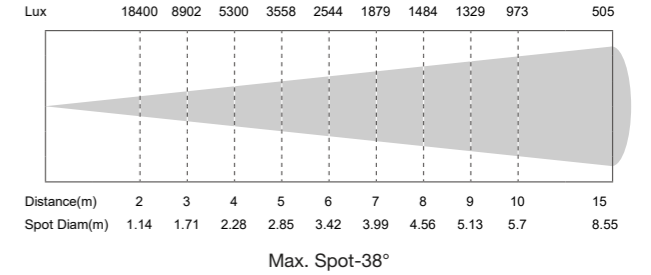
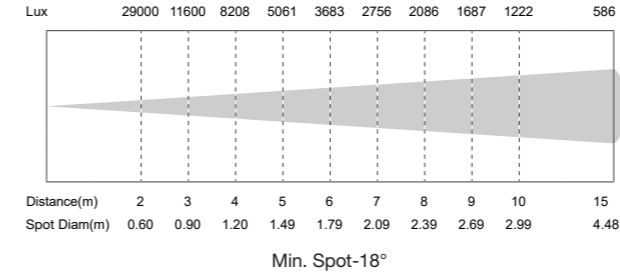

### Color Rendition

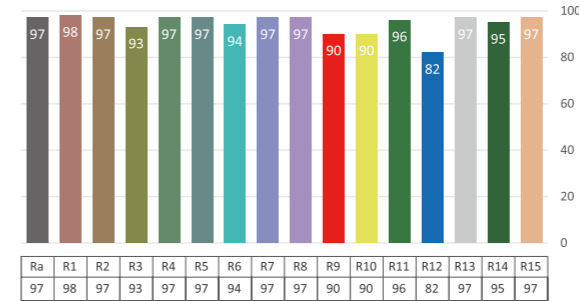

### Technical Data

Power supply:	AC100-240V, 50/60Hz
Light source:	300W COB LED
Color temperature:	3200K or 5600K
Zoom range:	18°-38°, 5°-10°, 9°-18° optional
Color Rendition:	CRI 97, R9≥90, TLCI 98, CQS 94
Power connection:	PowerCON in&out
Signal connection:	3-pin XLR in&out(5-pin opt.), Net in&out(opt.)
Control channels:	1/2/3
Control mode:	Rotary, DMX, RDM and Art-Net(optional)
Housing:	Color black, engineering plastic

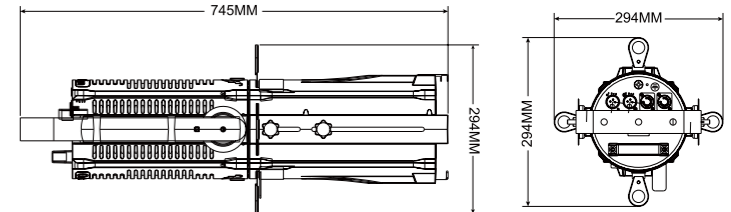

Size:	745 x 294 x 294mm
Package(carton):	790 x 350 x 360mm
N.W.:	8.7 kg
G.W.:	11.5 kg
Accessories(incl.):	Power cable, gel frame, Safety rope
Accessories(opt.):	Gobo holder, Clamp
GOBOSize:	OD 58mm, image area 50mm
Compliance:	CE, ETL(ArtNet ver.)
Environment:	IP20



# UHD 300

WW / CW

## 300W UHD LED profile zoom

Powered by 300W 3200K or 5600K LED, the UHD 300 is designed to replace the 1K tungsten halogen profile light. The 18-38° “all-in-one” zoom range covers the most regular 19°, 26°, 36° lens. Compatible with Gobo size A and B and industry standard lens.

### Key features:

- 300W COB white LED
- CRI 97, R9≥90, TLCI 98, CQS 94
- UHD optics, no deform for shapes
- 19-38° , 30-60° "all-in-one" zoom range
- 16 bit dimming via DMX
- Flicker free with selectable PWM
- RDM function, address change remotely
- Silent operation for studio and theatre use
- Artnet version optional
- Conform with Gobo size A and B and industry standard Iris
- Engine and lens compatible with industry

### Application:

- Broadcast, HD studio
- Theatre, church
- Fashion show
- Museum
- Exhibition lighting

### Accessories:

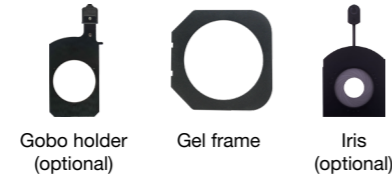

### Photometric 19~38°

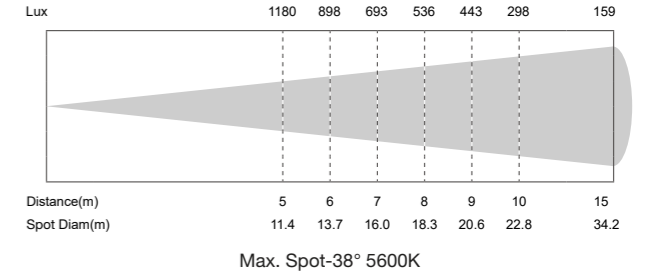
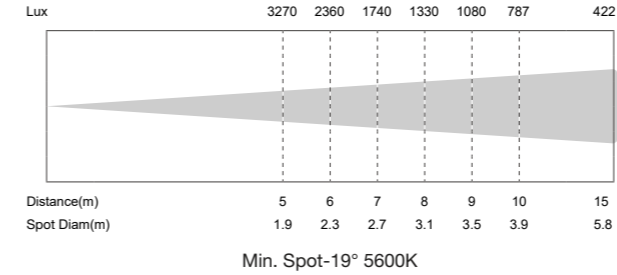

### Photometric 30~60°

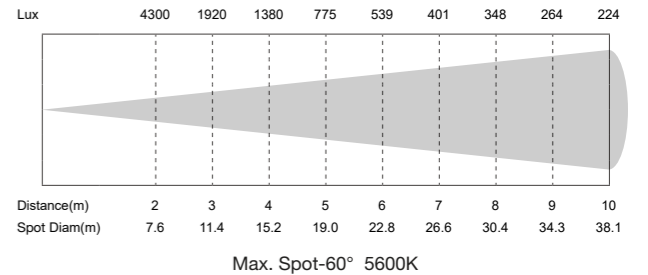
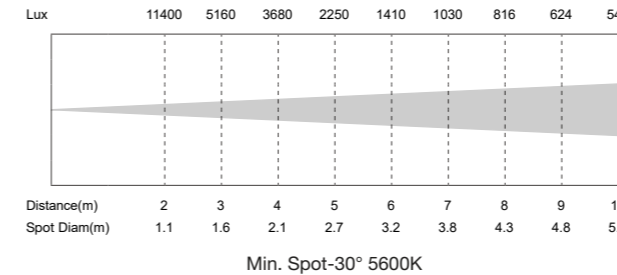

### Technical Data

Power supply:	AC100-240V, 50/60Hz
Light source:	300W COB LED
Color temperature:	3200K or 5600K
Zoom range:	19°-38° , 30°-60°
Color Rendition:	CRI 97, R9≥90, TLCI 98, CQS 94
Power connection:	PowerCON in & out
Signal connection:	3-pin XLR in&out(5-pin opt.), Net in&out(opt.)
Control channels:	1/2/3
Control mode:	Rotary, DMX, Art-Net and RDM
Housing:	Color black, engineering plastic

Size:	745 x 294 x 294mm
Package(carton):	790 x 350 x 360mm
N.W.:	10 kg
G.W.:	13 kg
Accessories(incl.):	Power cable, gel frame, safety rope
Accessories(opt.):	Gobo holder, clamp
GOBO size:	Gobo Size A and B
Compliance:	CE
Environment:	IP20



- 3200K/5600K
- RDM**  
Optional
- COB**  
300W LED
- ZOOM**
- Flicker Free
- 98**  
TLCI
- 97**  
CRI
- ARNET**  
Optional

Just by replace the lens tube without any tools, the Honor profile spot turns to a LED fresnel zoom. Featuring 300W high power 3200K/5600K LED, 97 CRI and 90 R9, flat and even field of light. It is designed to replace the traditional tungsten fresnels. The no noise operation makes it idea for studio and theatre.

# HONOR 300 FRESNEL

**WW / CW**

**300W LED fresnel zoom**

### Key features:

- 300W COB white LED
- 3200K/5600K color temperature
- CRI 97, R9≥90, TLCI up to 98
- Tool-free replacement between profile and fresnel
- Manual zoom function
- Smooth dimming, flicker free
- Rotary, key, DMX control of dimmer
- Intelligent temperature control, silent operation for studio and theatre use
- Artnet, RDM function optional, 4 dimmer modes

### Application:

- Broadcast, HD studio
- Theatre, church
- Fashion show
- Museum
- Exhibition lighting

### Accessories:

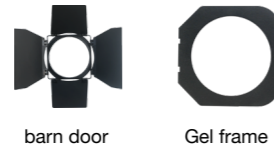

### Photometric

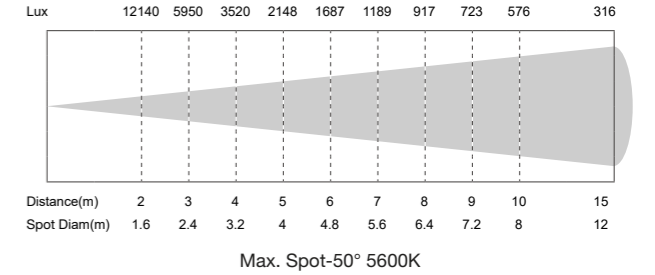
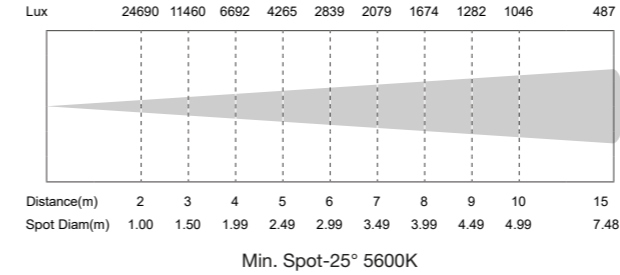

### Color Rendition



### Technical Data

Power supply:	AC100-240V, 50/60Hz
Light source:	300W COB LED
Color temperature:	3200K or 5600K
Zoom range:	25°- 50° manual zoom
Color Rendition:	CRI 97, R9≥90, TLCI 98, CQS 94
Power connection:	PowerCON in&out
Signal connection:	3-pin XLR in&out(5-pin opt.), Net in&out(opt.)
Control channels:	1/2/3
Control mode:	Rotary, DMX, Art-Net and RDM(optional)

Housing:	Color black, engineering plastic
Size:	562 x 248 x 189.4mm
Package(carton):	630 x 350 x 360mm
N.W.:	7.3 kg
G.W.:	10.5 kg
Accessories(incl.):	Power cable, barn door, Gel frame, Safety rope
Accessories(opt.):	Clamp
Compliance:	CE
Environment:	IP20



# HONOR 250C ZOOM

250W RGBW profile zoom

The Honor 250C Zoom is a 250W LED profile spot with RGBW color mixing. A good replacement of the tungsten source. The 18-38° all-in-one zoom range covers the most regular 19°, 26°, 36° lens.

### Key features:

- 250W RGBW LED
- 3000K ~ 8000K color temp
- HQ optical system, clean shutter cuts beam
- 18-38° “all-in-one” zoom range
- Smooth dimming, flicker free
- Rotary, Key, DMX control of dimmer
- Intelligent temperature control
- Engine and lens compatible with industry standard

### Application:

- Theatre, church
- Museum
- Exhibition lighting

### Accessories:

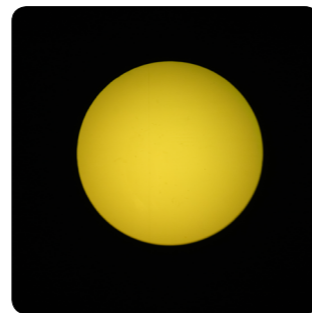
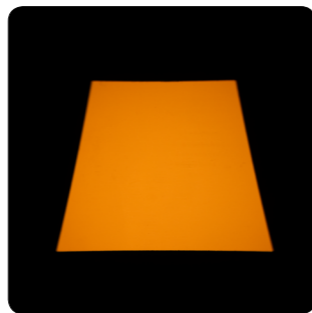
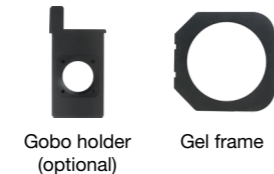

### Photometric

R(lx)	680	365	263	222	176	135	63
G(lx)	119	654	489	422	337	254	117
B(lx)	282	162	118	95	78	54	29
W(lx)	1940	1060	817	695	562	425	197
Full on(lx)	3840	2100	1580	1380	1100	839	390

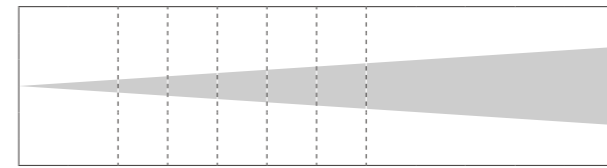

Distance(m)	5	6	7	8	9	10	15
Spot Diam(m)	1.49	1.79	2.09	2.39	2.69	2.99	4.48

Min. Spot-18°

R(lx)	234	164	112	85	68	56	27
G(lx)	414	281	207	160	126	102	52
B(lx)	101	64	53	42	30	24	13
w(lx)	682	450	345	263	213	125	89
Full on(lx)	1330	879	672	513	411	350	65

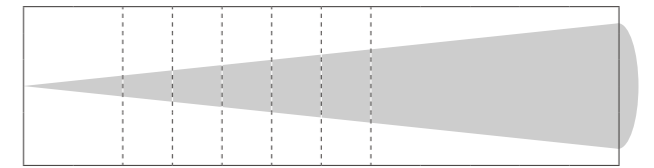

Distance(m)	5	6	7	8	9	10	15
Spot Diam(m)	2.85	3.42	3.99	4.56	5.13	5.7	8.55

Max. Spot-38°

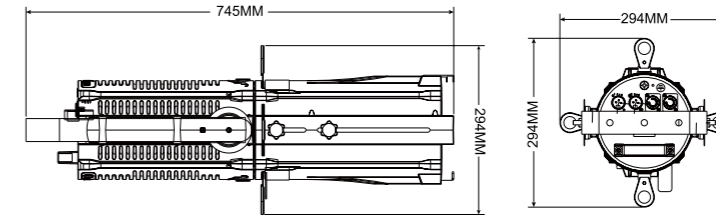

### Technical Data

Power supply:	AC100-240V, 50/60Hz
Light source:	250W LED
Color mixing:	RGBW
Color temperature:	3000K ~ 8000K tunable
Zoom range:	18°-38° , 5°-10°, 9°-18° optional
Power connection:	PowerCON in&out
Signal connection:	3-pin XLR in&out(5-pin opt.), Net in&out(opt.)
Control channels:	1/4/6/10
Control mode:	Rotary, DMX, RDM
Housing:	Color black, engineering plastic

Size:	745 x 294 x 294mm
Package(carton):	790 x 350 x 360mm
N.W.:	8.7 kg
G.W.:	11.5 kg
Accessories(incl.):	Power cable, Gel frame, Safety rope
Accessories(opt.):	Gobo holder, Clamp
GOBOSize:	OD 58mm, image area 50mm
Compliance:	CE
Environment:	IP20



# HONOR 350C ZOOM

## 350W 6 color profile zoom

The Honor 350C Zoom is a 350W LED profile spot with RGBAYC color mixing. A good replacement of the tungsten source. It creates a flat and even color mixing.

### Key features:

- 350W RGBAYC six color LED
- Super flat and even color mixing
- 3000~8000K color temp
- 18-38° "all-in-one" zoom range
- Smooth dimming, flicker free
- High CRI of 85
- Rotary, key, DMX control of dimmer
- Intelligent temperature control
- Artnet, RDM function
- Engine and lens compatible with industry standard

### Application:

- Theatre, church
- Museum
- Exhibition lighting

### Accessories:

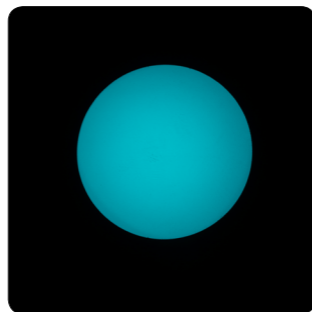
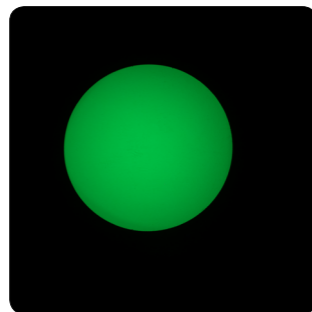
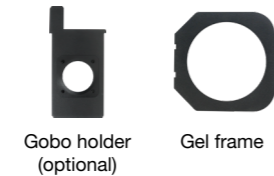

### Photometric

R(lx)	405	95	51
G(lx)	680	160	85
B(lx)	79	31	22
A(lx)	1440	340	181
Y(lx)	2260	510	281
C(lx)	430	102	54
Full on(lx)	4850	1120	618

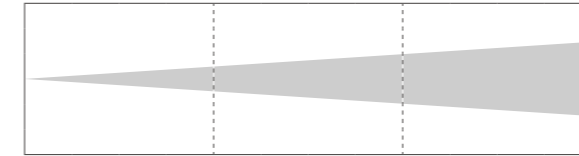

Distance(m)	5	10	15
Spot Diam(m)	1.49	2.99	4.48

Min. Spot-18°

R(lx)	128	36	51
G(lx)	229	57	30
B(lx)	62	15	8
A(lx)	496	125	68
Y(lx)	749	196	104
C(lx)	146	36	20
Full on(lx)	1550	420	220

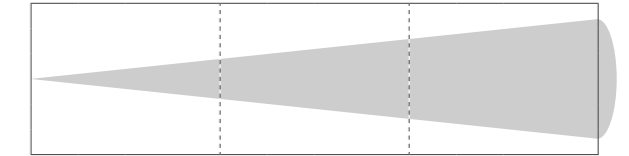

Distance(m)	5	10	15
Spot Diam(m)	2.85	5.7	8.55

Max. Spot-38°

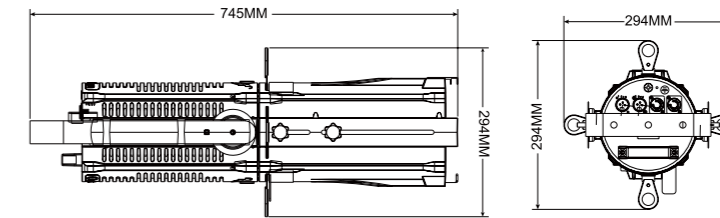

### Technical Data

Power supply:	AC100-240V, 50/60Hz	Housing:	Color black, engineering plastic
Light source:	350W RGBAYC LED	Size:	745 x 294 x 294mm
Color mixing:	RGBAYC(amber, yellow, cyan)	Package(carton):	790 x 350 x 360mm
Color temperature:	3000K ~ 8000K tunable	N.W.:	8.7 kg
Zoom range:	18°-38°, 5°-10°, 9°-18° optional	G.W.:	11.5 kg
Color Rendition:	CRI 85	Accessories(incl.):	Power cable, Gel frame, Safety rope
Power connection:	PowerCON in&out	Accessories(opt.):	Gobo holder, Clamp
Signal connection:	3-pin XLR in&out(5-pin opt.), Net in&out(opt.)	GOBOSize:	OD 58mm, image area 50mm
Control channels:	2/8/12	Compliance:	CE
Control mode:	Rotary, DMX, Art-Net and RDM	Environment:	IP20

THEATRICAL LIGHTING

THEATRICAL LIGHTING

3200K/5600K
RDM Control
COB 40W LED
ZOOM
Flicker Free
98 TLCI
95 CRI

# PINSPOT 40

WW / CW

40W LED fresnel

Pin Spot 40 is a 40W compact LED spotlight, the color temperature 3200K or 5600K, narrow and wide lens optional. It deliver a smooth, soft flat field of light. Idea for restaurant, shops.

### Key features:

- 40W COB LED
- CRI 95, R9≥90, TLCI 98, CQS 94
- 25° beam angle
- Smooth dimming, flicker free
- RDM function available
- Portable design, easy to set up
- DMX, Rotary control of dimmer
- 80° version optional
- Track mount version selectable

### Application:

- News interview
- Micro film shooting
- Small event
- Wedding shooting
- Exhibition lighting

### Accessories:



Gel frame



\*track mount version optional\*

### Photometric

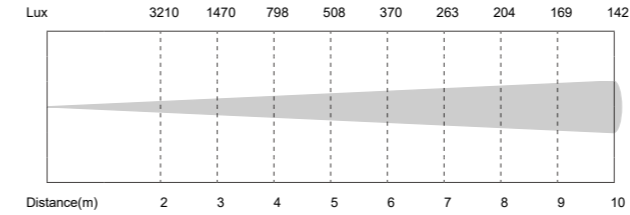

25°-3200K

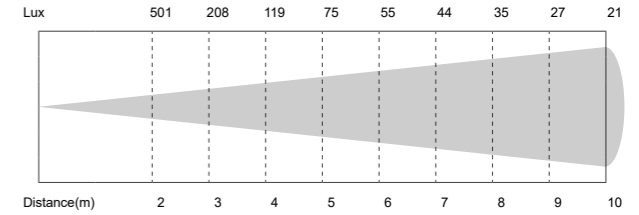

80°-3200K

### Color Rendition

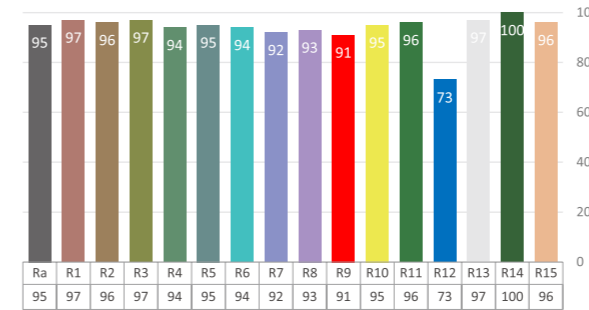

### Technical Data

Power supply:	AC100-240V, 50/60Hz
Light source:	40W COB LED
Color temperature:	3200K or 5600K
Beam angle:	25°(80° version optional)
Color Rendition:	CRI 95, R9≥90, TLCI 98, CQS 94
Power connection:	PowerCON in
Signal connection:	3-pin XLR in&out(5-pin optional)
Control channels:	1/2/3/4

Control mode:	DMX, RDM, Rotary
Dimmer speed:	4 grade
Housing:	Colour black, Aluminum
Size:	273 x 110 x 111mm
N.W.:	1.65 kg
Accessories(incl.):	Power cable
Accessories(opt.):	Gel frame, Clamp
Environment:	IP20

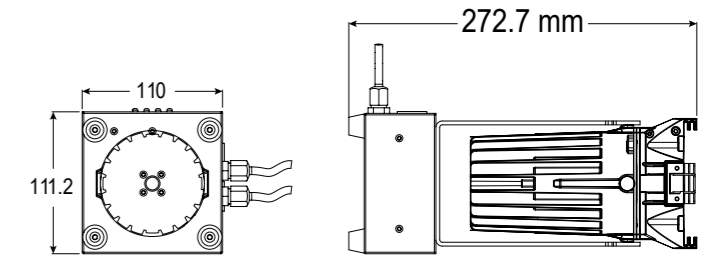

THEATRICAL LIGHTING

THEATRICAL LIGHTING

3200K/5600K RDM Control COB 40W LED ZOOM Flicker Free 98 TLCI 95 CRI

Designed for short distance wash. The mini Fresnel 40Z is a compact LED fresnel and powered by 40W 3200K tungsten or 5600K daylight LED. Featuring 25-80° zoom, 95CRI, 90 R9, rotary control of dimmer. It deliver a smooth, soft flat field of light. Barn door included for the shape of the light.

**Key features:**

- 40W COB white LED
- CRI 95, R9≥90, TLCI 98, CQS 94
- 25-80° manual zoom
- Smooth dimming, flicker free
- Super compact, easy for set up
- Rotary, key, DMX control of dimmer
- DMX-RDM compliant
- 4-leaf rotatable barndoor included
- Track mount version selectable

**Application:**

- News interview
- Micro film shooting
- Small event
- Wedding shooting
- Exhibition lighting

**Accessories:**



# MINI FRESNEL 40Z

WW / CW

40W LED fresnel zoom

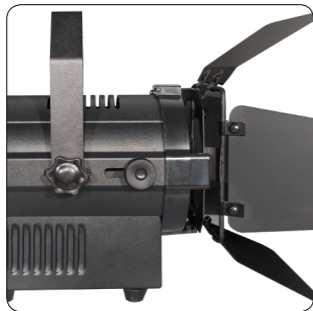

**Photometric**

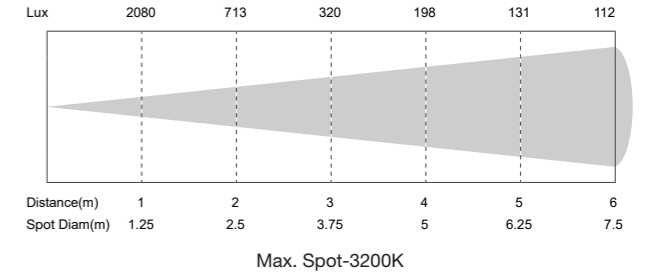
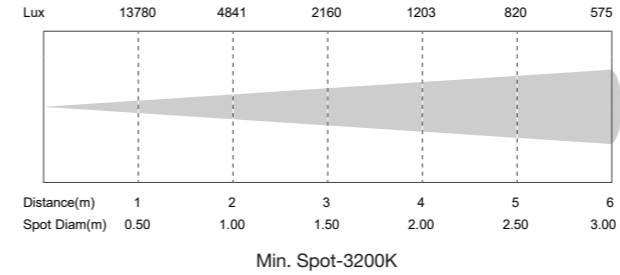

**Color Rendition**

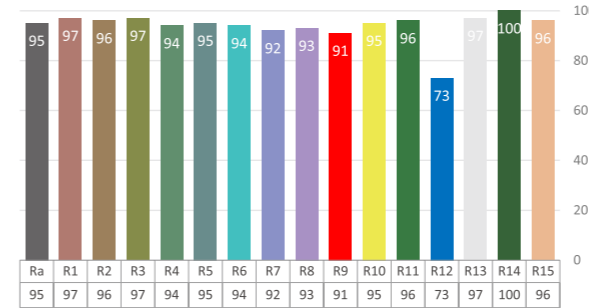

**Technical Data**

Power supply:	AC100-240V, 50/60Hz
Light source:	40W COB LED
Color temperature:	3200K or 5600K
Zoom range:	25°- 80° manual zoom
Color Rendition:	CRI 95, R9≥90, TLCI 98, CQS 94
Power connection:	PowerCON in
Signal connection:	3-pin XLR in&out(5-pin optional)
Control channels:	1/2/3/4
Control mode:	DMX, RDM, Rotary
Dimmer speed:	4 grade

Housing:	Colour black, Aluminum
Size:	230 x 156 x 279mm
Package(carton):	335 x 218 x 220mm
N.W.:	2.2 kg(barn door incl.)
G.W.:	2.8 kg
Accessories(incl.):	Power cable, barn door, Gel frame
Accessories(opt.):	Clamp, Safety rope
Compliance:	CE
Environment:	IP20

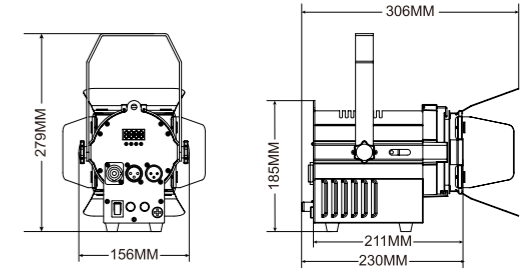

THEATRICAL LIGHTING

THEATRICAL LIGHTING



# MINI FRESNEL 50TZ

50W tunable fresnel zoom

The Mini Fresnel 50TZ is a compact LED fresnel and powered by 50W warm white and 50W cold white tunable LED. 25~80° zoom, 95CRI, 90 R9, rotary control of dimmer. It deliver a smooth, soft flat field of light. Barn door included for the shape of the light.

### Key features:

- 50W warm white + 50W cool white
- 2700K ~ 6500K tunable
- CRI 95, R9≥90, TLCI 98, CQS 96
- 25-80° manual zoom
- Smooth dimming, flicker free
- Super compact, easy for set up
- Rotary, key, DMX control of dimmer
- DMX-RDM compliant
- 4-leaf rotatable barndoor included
- Track mount version selectable

### Application:

- News interview
- Micro film shooting
- Small event
- Wedding shooting
- Exhibition lighting

### Accessories:

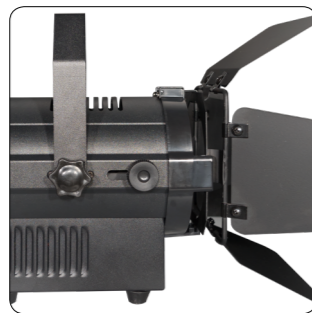

### Photometric

WW(lx)	6419	2986	946	543	352	240
CW(lx)	8804	2843	1312	759	495	329
Full on(lx)	7063	2216	1069	610	396	270

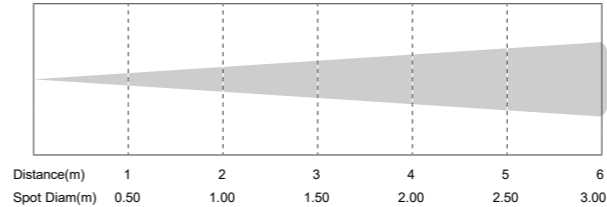

Distance(m)	1	2	3	4	5	6
Spot Diam(m)	0.50	1.00	1.50	2.00	2.50	3.00

Min. Spot

WW(lx)	1955	602	291	165	114	80
CW(lx)	2688	866	395	230	155	110
Full on(lx)	2150	698	319	185	126	90

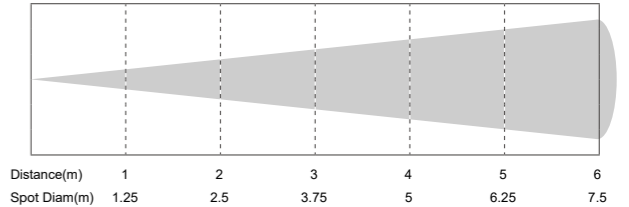

Distance(m)	1	2	3	4	5	6
Spot Diam(m)	1.25	2.5	3.75	5	6.25	7.5

Max. Spot

### Color Rendition

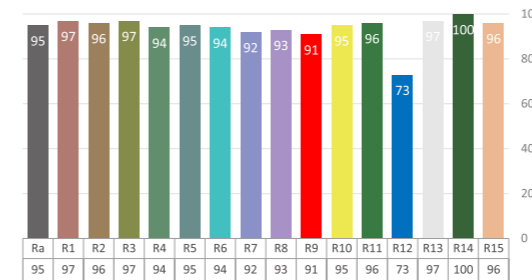

### Technical Data

Power supply:	AC100-240V, 50/60Hz
Light source:	50W WW + 50W CW
Color temperature:	2700K~6500K tunable
Zoom range:	25°- 80° manual zoom
Color Rendition:	CRI 95, R9≥90, TLCI 98, CQS 96
Power connection:	PowerCON in
Signal connection:	3-pin XLR in&out(5-pin optional)
Control channels:	1/2/3/5
Control mode:	DMX, RDM, Rotary

### Spectrum

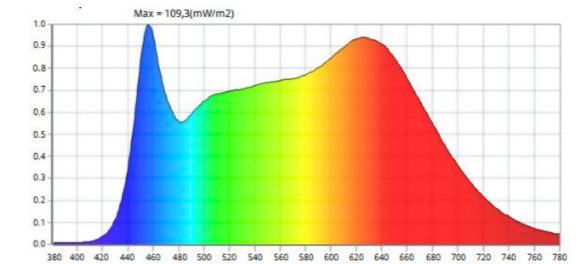

Housing:	Colour black, Aluminum
Size:	230 x 156 x 279mm
Package(carton):	335 x 218 x 220mm
N.W.:	2.2 kg(barn door incl.)
G.W.:	2.8 kg
Accessories(incl.):	Power cable, barn door, Gel frame
Accessories(opt.):	Clamp, Safety rope
Compliance:	CE
Environment:	IP20

THEATRICAL LIGHTING

THEATRICAL LIGHTING



Mini Fresnel 40CZ is a portable LED fresnel and powered by 40W RGBW LED. Featuring 25-80° zoom, even color mixing, 3000K ~ 8000 color temp. It deliver a smooth, soft flat field of light. Barn door included for the shape of the light.

**Key features:**

- 40W LED(40W R+40W G+40W B+40W W)
- RGBW flat and even color mixing
- 25-80° manual zoom
- Smooth dimming, flicker free
- Super compact, easy for set up
- Rotary, key, DMX control of dimmer
- DMX-RDM compliant, 4 dimmer modes
- 4-leaf rotatable barndoor included
- Track mount version selectable

**Application:**

- Small event
- Small theatre
- Stage wash

**Accessories:**



# MINI FRESNEL 40CZ

## 40W RGBW LED fresnel zoom

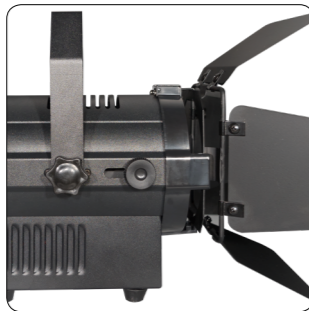

**Photometric**

R(lx)	273	125	72	43	36	26	23	17	13
G(lx)	620	295	170	108	83	63	58	41	33
B(lx)	151	82	52	33	27	17	15	11	9
W(lx)	740	328	199	132	95	75	69	53	37
Full on(lx)	438	207	120	75	60	43	37	29	25

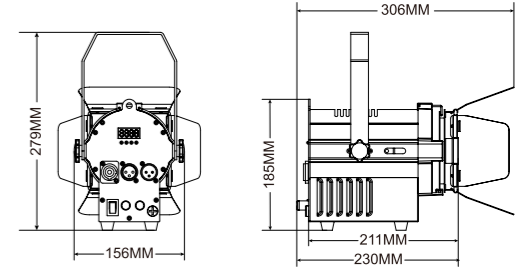
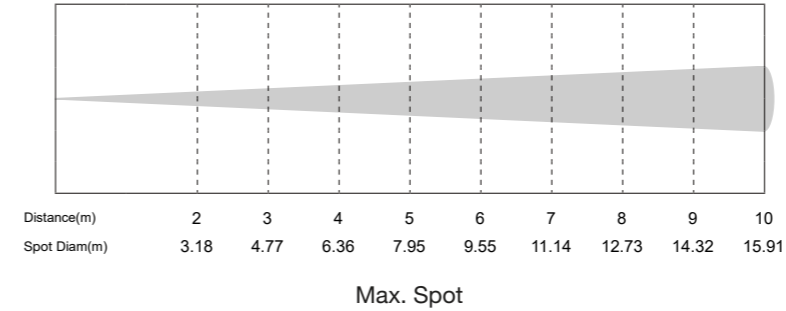

**Technical Data**

Power supply:	AC100-240V, 50/60Hz	Dimmer speed:	4 grade
Light source:	40W LED	Housing:	Colour black, Aluminum
LED color:	40W R+40W G+40W B+40W W	Size:	230 x 156 x 279mm
Color temperature:	3000K ~ 8000K	Package(carton):	335 x 218 x 220mm
Zoom range:	25° - 80° manual zoom	N.W.:	2.2 kg(barn door incl.)
Power connection:	PowerCON in	G.W.:	2.8 kg
Signal connection:	3-pin XLR in&out(5-pin optional)	Accessories(incl.):	Power cable, barn door, Gel frame
Control channels:	ARC.1(3CH), AR1.D(4CH), ARC.2(4CH), AR2.D(5CH), AR2.S(6CH), HSV(3CH), STAG(11CH)	Accessories(opt.):	Clamp, Safety rope
Control mode:	DMX, RDM	Compliance:	CE
		Environment:	IP20

THEATRICAL LIGHTING

THEATRICAL LIGHTING

3200K/5600K
RDM Control
COB 100W LED
ZOOM
Flicker Free
98 TLCI
97 CRI

# PIONEER 100 ZOOM

WW / CW

100W LED fresnel zoom

The Pioneer 100 Zoom is a 100W 3200K or 5600K powered LED fresnel with zoom function. The RDM-DMX compliant, 25-65 degree motorized zoom along with it's superior 97 CRI make this fixture a good replacement for the traditional fresnels.

### Key features:

- 100W COB white LED
- 3200K or 5600K color temperature
- CRI 97, R9≥90, TLCI 98, CQS 94
- Soft and even wash effect
- 25-65° motorized zoom
- Smooth dimming, flicker free
- DMX, RDM control
- Dimmer curves selectable
- Silent operation for studio and theatre

### Application:

- Broadcast, HD studio
- Theatre, church
- Film shooting
- Museum
- Exhibition lighting

### Accessories:

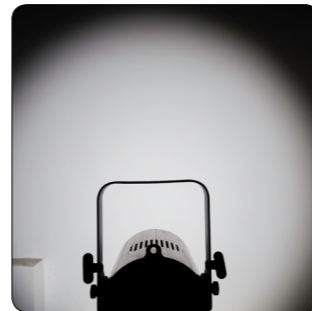

### Photometric

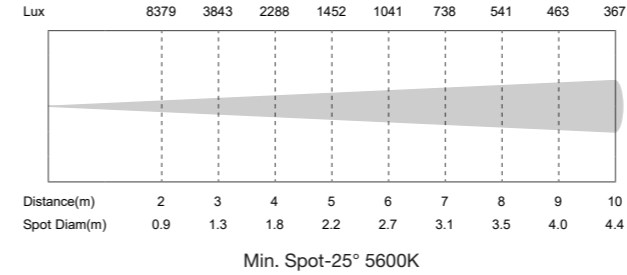

### Color Rendition

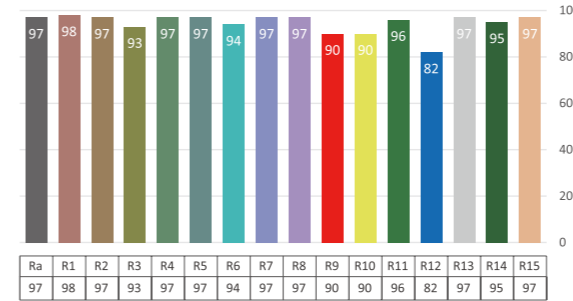

### Technical Data

Power supply:	AC100-240V, 50/60Hz
Light source:	100W COB LED
Color temperature:	3200K or 5600K
Zoom range:	25°-65° motorized zoom
Color Rendition:	CRI 97, R9≥90, TLCI 98, CQS 94
Power connection:	PowerCON in&out
Signal connection:	3-pin XLR in&out(5-pin optional)
Control channels:	2/3/4/5
Control mode:	DMX and RDM
Dimmer speed:	4 grade

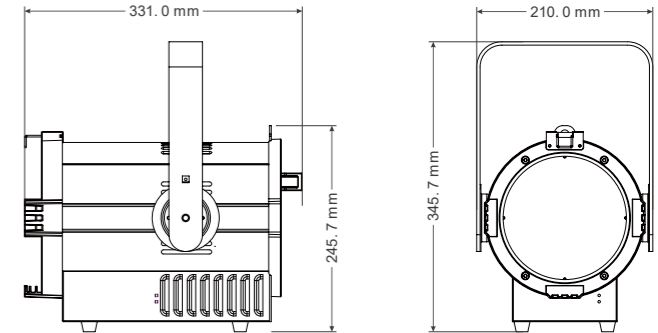
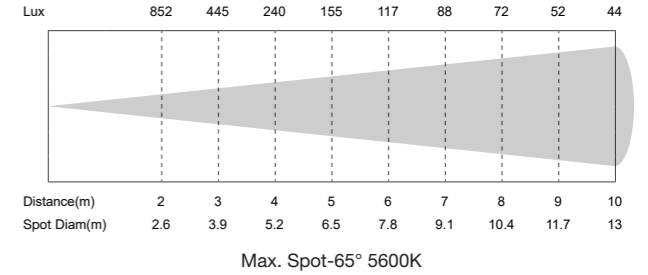

Housing:	Colour black, Aluminum
Size:	331 x 210 x 345.7mm
Package(carton):	448 x 338 x 400mm
N.W.:	6.6 kg(barn door incl.)
G.W.:	7.6 kg
Accessories(incl.):	Power cable, barn door, gel frame, safety rope
Accessories(opt.):	Clamp
Compliance:	CE
Environment:	IP20

THEATRICAL LIGHTING

THEATRICAL LIGHTING





# PIONEER 100C ZOOM

## 100W LED RGBW fresnel zoom

The Pioneer 100C Zoom is a 100W RGBW LED fresnel with zoom function. The RDM-DMX compliant, 25-65 degree motorized zoom along with it's flat and even make this fixture a good replacement for the traditional fresnels.

### Key features:

- 100W power LED
- RGBW color mixing
- Soft and even wash effect
- 25-65° motorized zoom
- Smooth dimming, flicker free
- DMX, RDM control
- Dimmer curves selectable
- Silent operation for studio and theatre

### Application:

- Theatre, church
- Film shooting
- Stage wash

### Accessories:

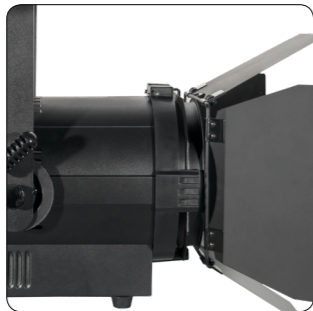

### Photometric

R(lx)	2699	378	193	129	98	75	55	42	34
G(lx)	1080	520	273	179	134	112	78	64	51
B(lx)	1289	139	74	48	34	27	18	14	11
W(lx)	1750	812	435	287	199	164	109	82	69
Full on(lx)	3730	780	665	608	433	315	275	199	167

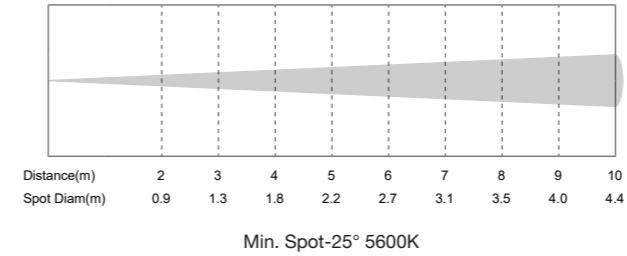

R(lx)	120	64	32	26	19	15	10	7	5
G(lx)	175	86	47	36	27	20	13	10	8
B(lx)	48	28	16	12	7	5	4	3	2
W(lx)	274	125	69	57	42	32	17	14	11
Full on(lx)	585	275	156	102	87	66	48	35	27

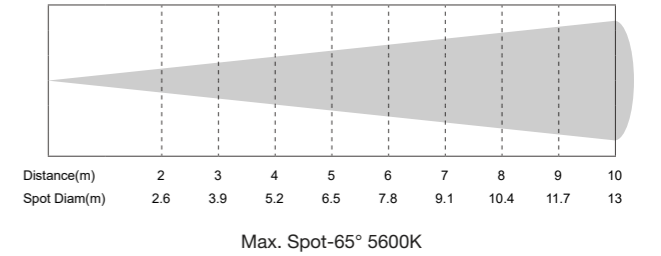

### Technical Data

Power supply:	AC100-240V, 50/60Hz
Light source:	100W RGBW LED
Color temperature:	3000K-8000K tunable
Zoom range:	25°-65° motorized zoom
Power connection:	PowerCON in&out
Signal connection:	3-pin XLR in&out(5-pin optional)
Control channels:	ARC.1(3CH), AR1.D(4CH), ARC.2(4CH), AR2.D(5CH), AR2.S(6CH), HSV(3CH), STAG(12CH)
Control mode:	DMX, RDM, Auto
Dimmer speed:	4 grade

Housing:	Colour black, Aluminum
Size:	331 x 210 x 345.7mm
Package(carton):	448 x 338 x 400mm
N.W.:	6.6 kg(barn door incl.)
G.W.:	7.6 kg
Accessories(incl.):	Power cable, barn door, gel frame, safety rope
Accessories(opt.):	Clamp
Compliance:	CE
Environment:	IP20

THEATRICAL LIGHTING

THEATRICAL LIGHTING

3200K/5600K RDM Control COB 200W LED ZOOM Flicker Free 98 TLCI 96 CRI

# PIONEER 200 ZOOM

WW / CW

200W LED fresnel zoom

The Pioneer 200 Zoom is a 200W 3200K or 5600K powered LED fresnel with zoom function. The RDM-DMX compliant, 15-60 degree motorized zoom along with it's superior 96 CRI make this fixture a good replacement for the traditional fresnels.

### Key features:

- 200W COB white LED
- 3200K or 5600K color temperature
- CRI 96, R9≥90, TLCI up to 98
- Soft and even wash effect
- 15-60° motorized zoom
- 16 bit dimming via DMX
- Video flicker free
- DMX, RDM control
- Dimmer modes selectable
- Intelligent fan, silent operation

### Application:

- Broadcast, HD studio
- Theatre, church
- Film shooting
- Museum
- Exhibition lighting

### Accessories:

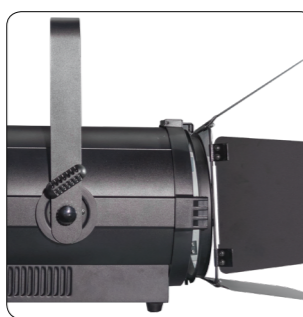
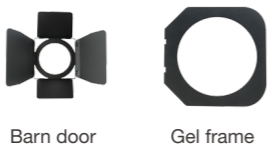

### Photometric

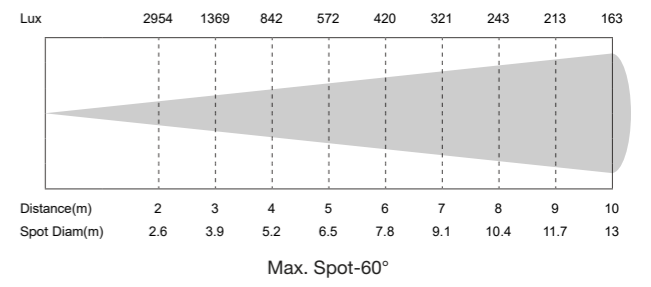
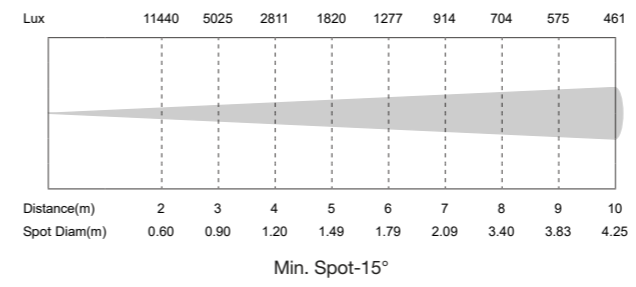

### Color Rendition

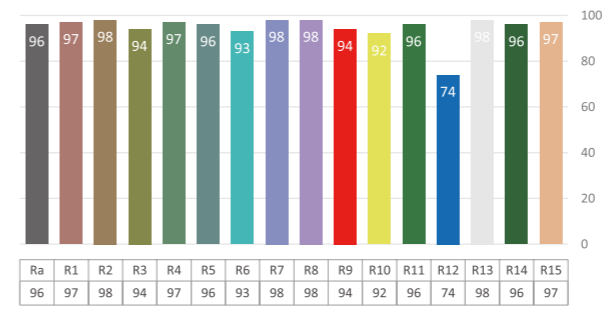

### Technical Data

Power supply:	AC100-240V, 50/60Hz
Light source:	200W COB LED
Color temperature:	3200K or 5600K
Zoom range:	15°-60° motorized zoom
Color Rendition:	CRI 96, R9≥90, TLCI 98, CQS 94
Power connection:	PowerCON in&out
Signal connection:	3-pin XLR in&out(5-pin optional)
Control channels:	2/3/4/5
Control mode:	DMX, RDM
Dimmer speed:	4 grade

Housing:	Colour black, Aluminum
Size:	315 x 296 x 330mm
Package(carton):	445 x 352 x 360mm
N.W.:	8 kg(barn door incl.)
G.W.:	9.8 kg
Accessories(incl.):	Power cable, barn door, gel frame, safety rope
Accessories(opt.):	Clamp
Compliance:	CE
Environment:	IP20

THEATRICAL LIGHTING

THEATRICAL LIGHTING



# PIONEER 200C ZOOM

## 200W RGBW LED fresnel zoom

The Pioneer 200C Zoom is a 200W RGBW powered LED fresnel with zoom function. The RDM-DMX compliant, 15-60 degree motorized zoom along with its superior color mixing make this fixture a good replacement for the traditional fresnels.

### Key features:

- 200W LED
- RGBW perfect color mixing
- Soft and even wash effect
- 15-60° motorized zoom
- 16 bit dimming via DMX
- Video flicker free
- DMX, RDM control
- Dimmer modes selectable
- Intelligent fan, silent operation

### Application:

- Theatre, church
- Stage wash
- Exhibition lighting

### Accessories:



### Photometric

R(lx)	852	398	207	137	91	67	49	39	32
G(lx)	1755	764	441	273	192	137	103	76	67
B(lx)	456	176	105	64	44	32	23	14	12
W(lx)	2241	980	564	360	247	183	129	104	82
Full on(lx)	6139	2308	1276	811	565	412	301	241	206

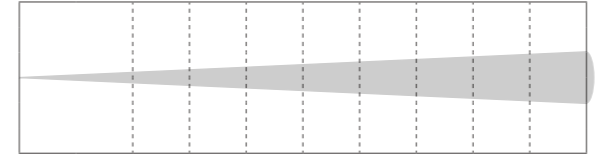

Distance(m)	2	3	4	5	6	7	8	9	10
Spot Diam(m)	0.60	0.90	1.20	1.49	1.79	2.09	3.40	3.83	4.25

Min. Spot-15°

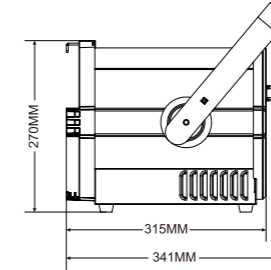

### Technical Data

Power supply:	AC100-240V, 50/60Hz
Light source:	200W LED
Color mixing:	RGBW
Color temperature:	3000K ~ 8000K
Zoom range:	15°-60° motorized zoom
Power connection:	PowerCON in&out
Signal connection:	3-pin XLR in&out(5-pin optional)
Control channels:	ARC.1(3CH), AR1.D(4CH), ARC.2(4CH), AR2.D(5CH), AR2.S(6CH), HSV(3CH), STAG(12CH)
Control mode:	DMX, RDM, Auto

R(lx)	269	108	62	40	29	21	18	14	10
G(lx)	542	238	132	84	62	46	35	29	22
B(lx)	113	54	30	20	11	7	6	5	4
W(lx)	695	295	172	106	81	56	49	39	33
Full on(lx)	1367	689	395	249	180	167	108	94	76

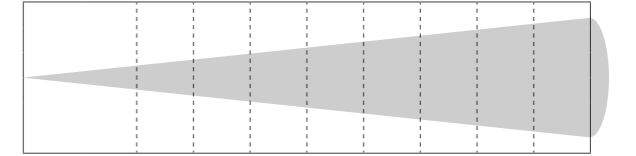

Distance(m)	2	3	4	5	6	7	8	9	10
Spot Diam(m)	2.6	3.9	5.2	6.5	7.8	9.1	10.4	11.7	13

Max. Spot-60°

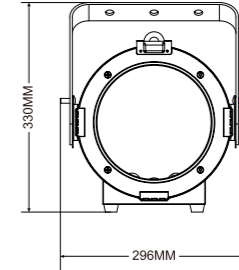

Dimmer speed:	4 grade
Housing:	Colour black, Aluminum
Size:	315 x 296 x 330mm
Package(carton):	445 x 352 x 360mm
N.W.:	8 kg(barn door incl.)
G.W.:	9.8 kg
Accessories(incl.):	Power cable, barn door, gel frame, safety rope
Accessories(opt.):	Clamp
Compliance:	CE
Environment:	IP20

THEATRICAL LIGHTING

THEATRICAL LIGHTING



# PIONEER 300 ZOOM

WW / CW

300W LED fresnel zoom

The Pioneer 300 Zoom is a 300W 3200K or 5600K powered LED fresnel. Features motorized zoom range from 8°~ 60°. It's high power light output, high CRI, DMX, RDM, ArtNet, soft wash effect make this fixture a perfect replacement of the traditional 1K fresnels.

### Key features:

- 300W COB white LED, 3200K/5600K optional
- 1KW tungsten equivalent
- CRI 97, R9≥90, TLCI 98, CQS 94
- Artnet, RDM, DMX control
- 4 dimmer curves selectable
- 8-60° motorized zoom
- 16 bit dimming
- Flicker free with selectable PWM
- Rotary, key, DMX control of dimmer and zoom
- Silent operation for studio and theater use

### Application:

- Broadcast, HD studio
- Theatre, church
- Film shooting
- Museum
- Exhibition lighting

### Accessories:



### Photometric

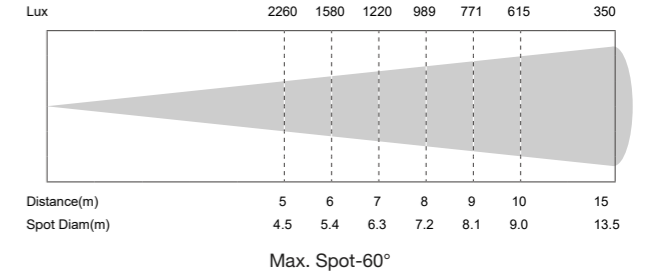
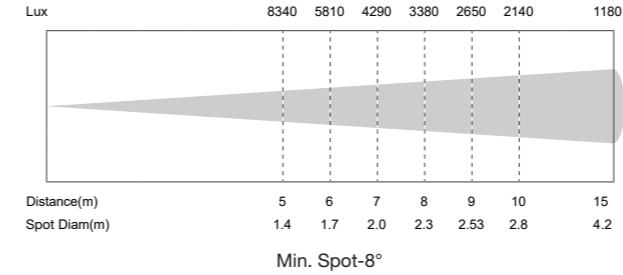

### Color Rendition

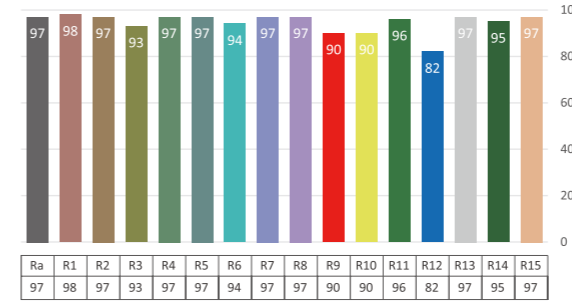

### Technical Data

Power supply:	AC100-240V, 50/60Hz
Light source:	300W COB LED
Color temperature:	3200K or 5600K
Zoom range:	8° ~ 60° motorized zoom
Color Rendition:	CRI 97, R9≥90, TLCI 98, CQS 94
Power connection:	PowerCON in&out
Signal connection:	3-pin XLR in&out(5-pin optional), Net in & out
Control channels:	1/2/3/4
Control mode:	Rotary, DMX, Art-Net and RDM
Dimmer curves:	Standard/ Stage/ TV/ Architecture/ Theatre

Housing:	Colour black, Aluminum
Size:	460 x 320 x 440mm
Package(carton):	520 x 360 x 345mm
N.W.:	11 kg(barn door incl.)
G.W.:	13 kg
Accessories(incl.):	Power cable, barn door, gel frame, safety rope
Accessories(opt.):	Clamp
Compliance:	CE
Environment:	IP20

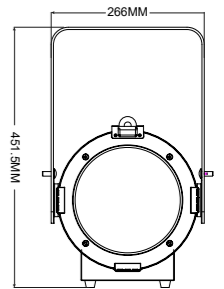
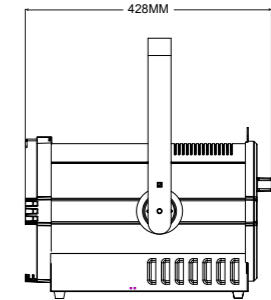

THEATRICAL LIGHTING

THEATRICAL LIGHTING



The Pioneer 350C Zoom is a 350W RGBAYC powered LED fresnel with zoom function. The RDM-DMX compliant, 20-55 degree motorized zoom along with its superior color mixing make this fixture a good replacement for the traditional fresnels.

**Key features:**

- 350W LED
- RGBAYC 6 color mixing
- Soft and even wash effect
- High CRI of 85
- 20-55° motorized zoom
- 16 bit dimming via DMX
- Video flicker free
- DMX, RDM control
- Dimmer modes selectable
- Intelligent temperature control

**Application:**

- Theatre, church
- Film shooting
- Museum
- Stage wash

**Accessories:**



# PIONEER 350C ZOOM

350W 6 color LED fresnel zoom

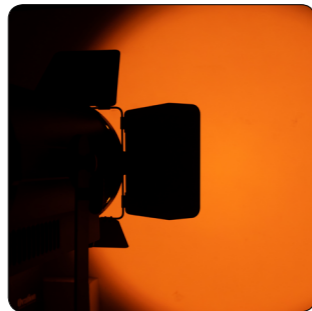

**Photometric**

R(lx)	256	187	141	105	92	75
G(lx)	434	334	246	193	155	126
B(lx)	124	97	70	55	45	36
A(lx)	905	676	513	396	326	263
Y(lx)	1430	1050	811	633	513	415
C(lx)	278	217	157	124	97	81
Full on(lx)	3220	2420	1800	1400	1120	925

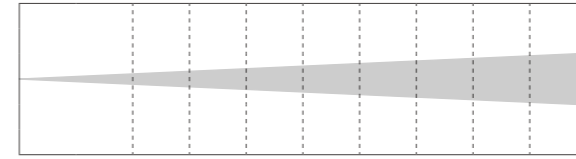

Distance(m)	5	6	7	8	9	10
Spot Diam(m)	1.49	1.79	2.09	3.40	3.83	4.25

Min. Spot-20°

R(lx)	31	26	21	17	13.5	11
G(lx)	56	43	33	27	21	17
B(lx)	16	12	10	8	6	5
A(lx)	121	94	71	59	47	37
Y(lx)	189	142	110	89	73	59
C(lx)	36	28	22	19	14	11
Full on(lx)	412	334	254	202	163	126

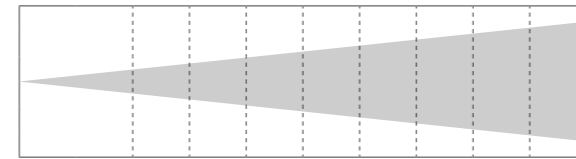

Distance(m)	5	6	7	8	9	10
Spot Diam(m)	6.5	7.8	9.1	10.4	11.7	13

Max. Spot-55°

**Color Rendition**

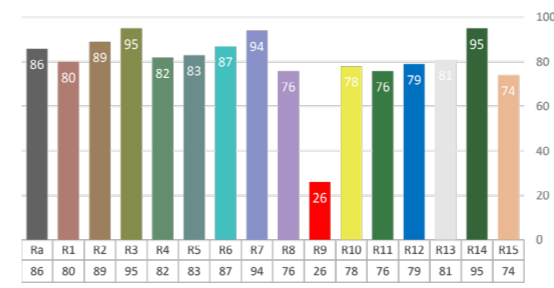

**Technical Data**

Power supply:	AC100-240V, 50/60Hz
Light source:	350W COB LED
Color temperature:	3000K ~ 8000K
Zoom range:	20°-55° motorized zoom
Color Rendition:	CRI 86
Power connection:	PowerCON in&out
Signal connection:	3-pin XLR in&out(5-pin optional), Net in & out
Control channels:	2/8/13
Control mode:	Rotary, DMX, Art-Net, RDM, Auto
Dimmer speed:	Standard/ Stage/ TV/ Architecture/ Theatre
Housing:	Colour black, Aluminum
Size:	460 x 320 x 440mm
Package(carton):	520 x 360 x 345mm
N.W.:	11 kg(barn door incl.)
G.W.:	13 kg
Accessories(incl.):	Power cable, barn door, gel frame, safety rope
Accessories(opt.):	Clamp
Compliance:	CE
Environment:	IP20

THEATRICAL LIGHTING

THEATRICAL LIGHTING



# PAR MASTER X1

WW / CW

150W LED zoom par

Powered by 150W 3200K or 5600K LED, the Par Master X1 is designed to replace the traditional lamp 1000W halogen par64. Featuring manual zoom range from 25°-80°, 96 CRI and R9 up to 94, durable LED life, compact design. It creates a flat and even field of light.

### Key features:

- 150W COB white LED
- 3200K or 5600K color temperature selectable
- Manually zoom, range from 25°-80°
- High CRI 96, R9 up to 94
- TLCI up to 98
- DMX-RDM compliant
- Video flicker free
- Equal to S4 HPL750 par

### Application:

- Theatre, church
- Film shooting
- Museum
- Exhibition lighting

### Accessories:



Barn door



Gel frame



### Photometric

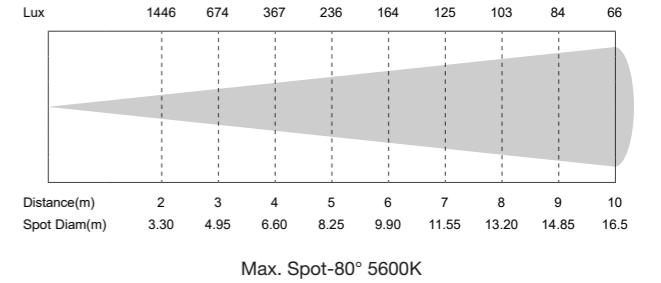
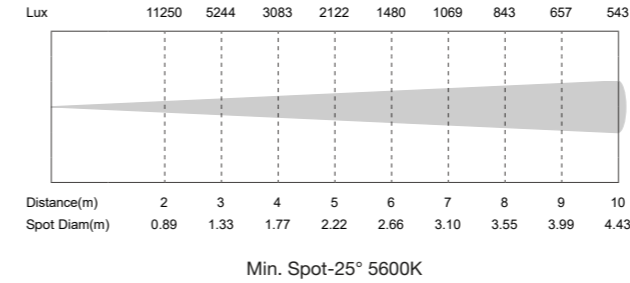

### Color Rendition

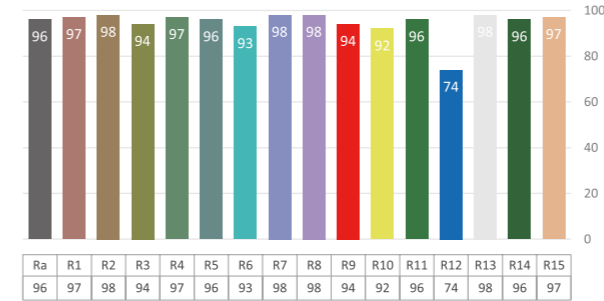

### Technical Data

Power supply:	AC100-240V, 50/60Hz
Light source:	150W COB LED
Color temperature:	3200K or 5600K
Zoom range:	25°- 80° manual zoom
Color Rendition:	CRI 96, R9≥90, TLCI 98, CQS 94
Power connection:	IP power cable in&out
Signal connection:	3-pin XLR in&out(5-pin optional)
Control channels:	1/2/3/4
Control mode:	DMX, RDM

Dimmer speed:	4 grade
Housing:	Colour black, Aluminum
Size:	290 x 260 x 305mm
Package(carton):	290 x 290 x 350mm
N.W.:	5 kg(barn door incl.)
G.W.:	5.6 kg
Accessories(incl.):	Power cable, barn door, Gel frame
Accessories(opt.):	Clamp, Safety rope
Environment:	IP20

THEATRICAL LIGHTING

THEATRICAL LIGHTING



# PAR MASTER C1

## 150W LED RGBW zoom par

Powered by 150W RGBW LED, the Par Master C1 is designed to replace the traditional lamp par. Featuring manual zoom range from 25°-80°, durable LED life, compact design, flat and even field of light.

### Key features:

- 150W LED
- RGBW color mixing
- Flat and even color mixing
- Manually zoom, range from 25°-80°
- DMX-RDM compliant
- Video flicker free
- Four leaf rotatable barn door

### Application:

- Theatre, church
- Stage wash
- Wedding
- Exhibition lighting

### Accessories:



### Photometric

R(lx)	1190	476	302	189	127	93	83	59	55
G(lx)	1920	856	526	331	228	169	139	114	93
B(lx)	487	239	143	87	62	46	37	29	27
W(lx)	2750	1230	752	473	329	244	195	159	127
Full on(lx)	6230	2780	1670	1050	699	526	438	334	289

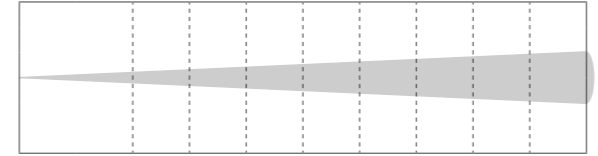

Distance(m)	2	3	4	5	6	7	8	9	10
Spot Diam(m)	0.89	1.33	1.77	2.22	2.66	3.10	3.55	3.99	4.43

Min. Spot-25°

R(lx)	142	79	69	58	25	16	12	9	7
G(lx)	254	134	126	87	38	27	19	16	13
B(lx)	68	36	33	27	19	13	8	7	5
W(lx)	372	189	169	121	56	39	36	25	19
Full on(lx)	765	395	365	270	112	86	66	57	39

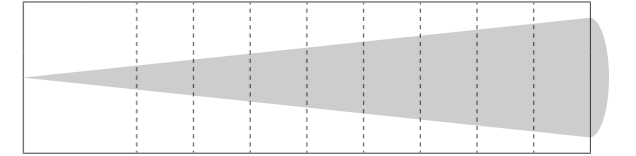

Distance(m)	2	3	4	5	6	7	8	9	10
Spot Diam(m)	3.30	4.95	6.60	8.25	9.90	11.55	13.20	14.85	16.5

Max. Spot-80°

### Technical Data

Power supply:	AC100-240V, 50/60Hz
Light source:	150W RGBW LED
Color mixing:	RGBW
Color temperature:	3000K~8000K
Zoom range:	25°- 80° manual zoom
Power connection:	IP power cable in&out
Signal connection:	3-pin XLR in&out(5-pin optional)
Control channels:	ARC.1(3CH), AR1.D(4CH), ARC.2(4CH), AR2.D(5CH), AR2.S(6CH), HSV(3CH), STAG(11CH)
Control mode:	DMX, RDM, Auto

Dimmer speed:	4 grade
Housing:	Colour black, Aluminum
Size:	290 x 260 x 305mm
Package(carton):	290 x 290 x 350mm
N.W.:	5 kg(barn door incl.)
G.W.:	5.6 kg
Accessories(incl.):	Power cable, barn door, gel frame
Accessories(opt.):	Clamp, safety rope
Environment:	IP20

THEATRICAL LIGHTING

THEATRICAL LIGHTING



# CANNON PAR

WW / CW

150W LED fresnel zoom

The Cannon Par is a 150W COB LED powered fresnel par light with manually zoom. The zoom range from 10-55°. The brightness equals to 1000W halogen par64 lamp. It features low power draw but high output, DMX/RDM control, powerCon in&out, manual zoom.

### Key features:

- 150W COB LED
- 3200K or 5600K color temperature selectable
- 10-55° manual zoom
- High CRI 96, R9≥90
- DMX, RDM control
- 4 dimmer modes
- Smooth dimming, flicker free
- Equal to 1000W halogen par64 lamp

### Application:

- Theatre, church
- Film shooting
- Museum
- Exhibition lighting
- Stage

### Accessories:



### Photometric

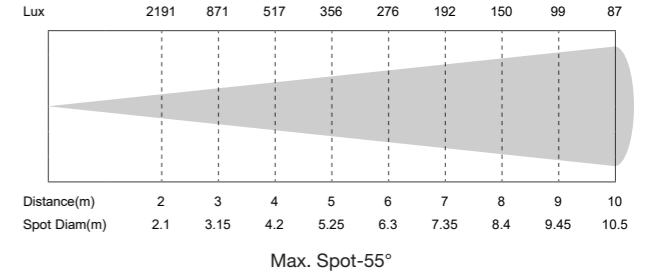
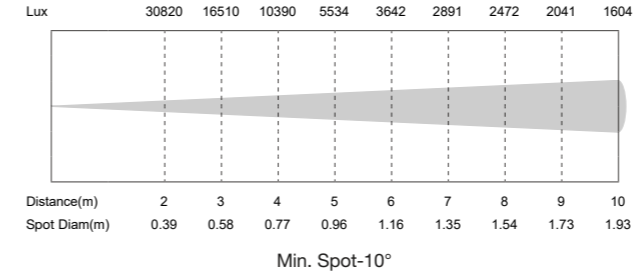

### Color Rendition

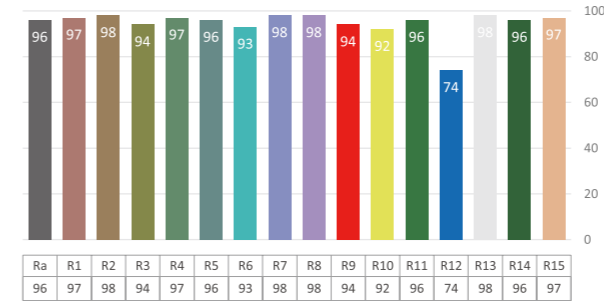

### Technical Data

Power supply:	AC100-240V, 50/60Hz
Light source:	150W COB LED
Color temperature:	3200K or 5600K
Zoom range:	10°-55° manual zoom
Color Rendition:	CRI 96, R9≥90, TLCI 98, CQS 94
Power connection:	PowerCON in&out
Signal connection:	3-pin XLR in&out(5-pin optional)
Control channels:	1/2/3/4
Control mode:	DMX, RDM

Dimmer speed:	4 grade
Housing:	Colour black, Aluminum
Size:	384 x 296 x 347mm
Package(carton):	490x 350 x 330mm
N.W.:	6 kg
G.W.:	8.3 kg
Accessories(incl.):	Power cable, barn door, gel frame, Safety rope
Accessories(opt.):	Clamp
Environment:	IP20



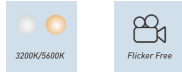

# POWER PAR 350

WW / CW

The Power par 350 series is powered by 31x10W LED. With warm white, pure white or tunable LEDs selectable. Features extremely high brightness and compact body. It's high power light output, even wash effect make this fixture a perfect replacement of the traditional 575W power par.

### Key features:

- 31x10W LED
- WW, CW, tunable white optional
- Super bright
- Long distance throw
- Various LED color selectable
- Video flicker free
- HQ LEDs, long life time
- Die-cast aluminum body
- PowerCon in & out connection

### Application:

- Auto exhibition
- Large event
- Stadium
- Shopping mall
- Display lighting

### Accessories:

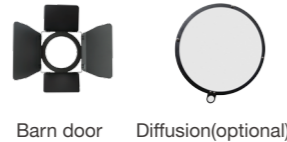

### Photometric

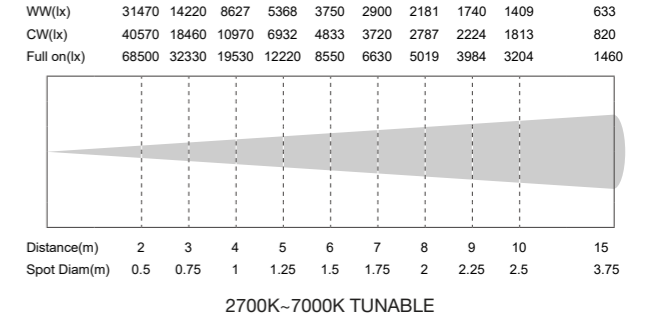
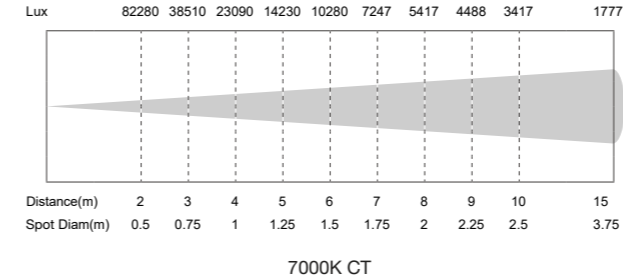

### Technical Data

Power supply:	AC100-240V, 50/60Hz
Light source:	31 x 10W LED
Color temperature:	2700K/7000K/tunable white
Beam angle:	25°
Power connection:	PowerCON in&out
Signal connection:	3-pin XLR in&out(5-pin optional)
Control channels:	2
Control mode:	DMX 512
Housing:	Color black, aluminum

Size:	507 x 269 x 269mm
Package(carton):	320 x 320 x 570mm
N.W.:	7.4 kg(barn door incl.)
G.W.:	10 kg
Accessories(incl.):	Power cable, barn door, safety rope
Accessories(opt.):	Diffusion lens, clamp
Compliance:	CE
Environment:	IP20

### Size

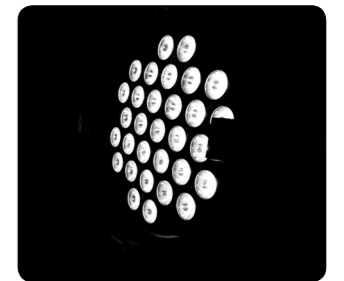
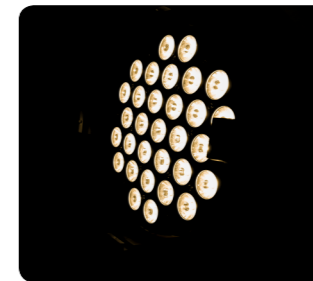
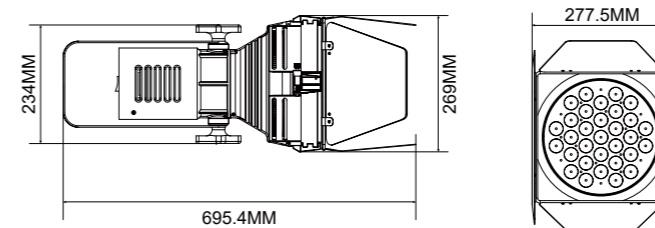

THEATRICAL LIGHTING

THEATRICAL LIGHTING



### Key features:

- 4 x 100W LED, high brightness
- Individual control of each LED
- 3200K~5600K tunable, single white optional
- Smooth dimming, flicker free
- Aluminum housing



## BLINDER 400

4 eye blinder

### Technical Data

Power supply:	AC100-240V, 50/60Hz
Light source:	4 x 100W LED
Color temperature:	3200K~5600K, single white optional
Beam angle:	60°
Power connection:	PowerCON in&out
Signal connection:	3-pin XLR in&out
Control channels:	2/6/12
Control mode:	DMX 512
Housing:	Colour black, Aluminum
Package(carton):	430 x 270 x 420mm
N.W.:	8.5 kg
Accessories:	Power cable
Environment:	IP20



### Key features:

- 108 x 3W SMD LED
- RGBW(27R, 27G, 27B, 27W) LED
- Even color mixing
- Aluminum housing

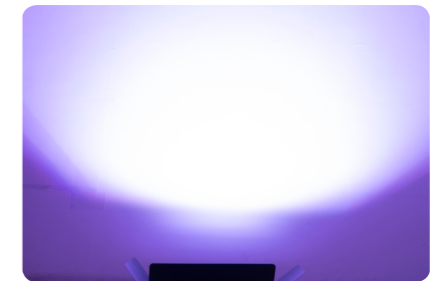
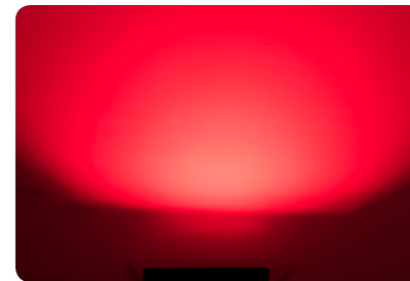

## SKY PANEL 108

108 x 3W LED panel

### Technical Data

Power supply:	AC100-240V, 50/60Hz
Light source:	108 x 3W SMD LED
Color mixing:	RGBW(27R, 27G, 27B, 27W) LED
Beam angle:	60°x120°
Power connection:	PowerCON in&out
Signal connection:	3-pin XLR in&out
Control channels:	8
Control mode:	DMX 512
Housing:	Colour black, Aluminum
Size:	480 x 270 x 127mm
Package:	505 x 200 x 125mm
N.W.:	8.5 kg
G.W.:	9.5 kg
Accessories:	Power cable, barn door
Environment:	IP20

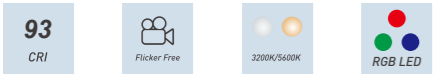

# PANEL 200

200W LED panel

- Key features:**
- 490 x 0.5W high brightness SMD LED
  - Color temp 3200K/5600K optional
  - High CRI of 93 Ra
  - 120° beam angle
  - Aluminum housing, silent operation

**Technical Data**

Power supply:	AC100-240V, 50/60Hz
Light source:	490 x 0.5W SMD LED
Color temperature:	3200K/5600K optional
Beam angle:	120°
Power connection:	PowerCON in&out
Signal connection:	3-pin XLR in&out
Control channels:	1/2
Control mode:	DMX 512
Housing:	Colour black, Aluminum
Size:	480 x 270 x 127mm
Package:	505 x 200 x 125mm
N.W.:	8.5 kg
G.W.:	9.5 kg
Accessories:	Power cable, barn door
Environment:	IP20



# STROBE 1000 RGB

200W LED strobe

- Key features:**
- 200W RGBW LED strobe
  - 1000 pcs SMD LED
  - Even color mixing, bright
  - Strobe, Blinder, Wash all in one
  - Aluminum housing
  - Segment control

**Technical Data**

Power supply:	AC100-240V, 50/60Hz
Light source:	1000 x 0.3W SMD LED
Power consum.	230W
Color mixing:	RGB 3in1
Color temperature:	6500K~7500K
Power connection:	PowerCON in&out
Signal connection:	3-pin XLR in&out
Control channels:	8
Control mode:	DMX 512, Sound, Auto
Housing:	Colour black, Aluminum
Size:	540 x 275 x 140mm
Package:	540 x 320 x 205mm
N.W.:	7.5 kg
G.W.:	8 kg
Accessories:	Power cable
Environment:	IP20

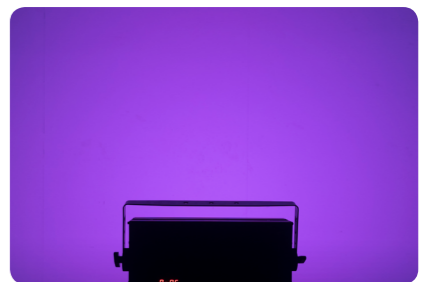
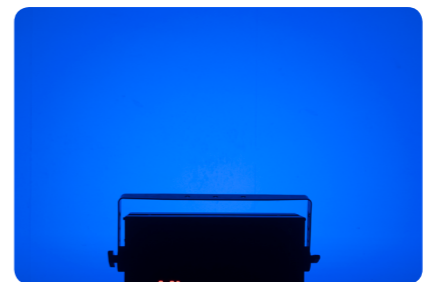

THEATRICAL LIGHTING

THEATRICAL LIGHTING

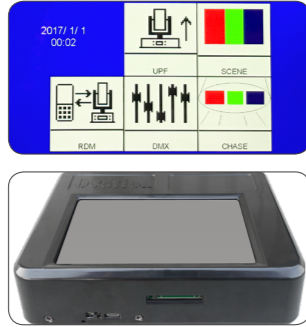

The RDM DMX RC1 is a palm sized RDM/DMX controller. It can monitor and control DMX units compliant with RDM. DMX addresses can be detected and set remotely. It features compact and modern design, battery powered, touch screen and SD card available for storage of chases and scenes.

#### Key features:

- RDM Compliant
- Monitor and control and RDM devices
- Detect and set DMX address remotely
- SD card for storage chases and scenes and firmware update
- Battery powered, 8-hours' operation
- Charged via 5V 2A Micro-USB charger
- 5 inch capacitive touchscreen

## RDM DMX RC1

### DMX/RDM controller

#### Technical Data

Power supply:	5V via charger at 100-240 V AC, 50/60 Hz
Power connection:	Micro USB
DMX512/RDM:	3-pin and 5-pin XLR in&out
Display:	5" 480x854 IPS capacitive touchscreen
Battery pack type:	Li-ion 3.7V 2000mAh 7.4Wh x 2
Battery life:	8 hrs
Control protocol:	DMX, RDM
Housing:	Colour black, Plastic cover, Steel base
Size:	170 x 113 x 48mm
N.W.:	0.6kg
Environment:	IP20

#### Size

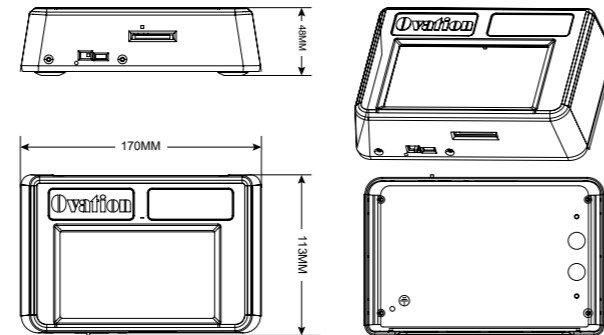

#### Key features:

- RDM Compliant
- Multi-voltage auto-switching power supply
- 2 XLR (3-pin) for DMX input
- 8 optically isolated XLR plugs (3-pin) for DMX output
- LED indication for functions
- 1 x IEC in port
- Rack or truss mount possible



#### Key features:

- Distributes Art-Net data to 8 DMX512 universes (4096 channels)
- 8 optically isolated XLR plugs (3-pin) for DMX output
- 2 XLR (3-pin) for DMX input
- Variable data routing capabilities for all DMX outputs
- Serial connection possible
- User-friendly configuration directly at the front panel via 4 operating buttons and alphanumeric LCD screen (2 x 16 characters)
- LED indication for functions
- DMX Splitter / DMX booster operation possible

## RDM DMX SP8

### 8 way DMX/RDM splitter

#### Technical Data

Power supply:	110-240 V AC, 50/60 Hz
Power connection:	PowerCON in&out
Signal inputs:	2 x 3-pin XLR male
Signal outputs:	8 x 3-pin XLR female
Control connection:	RDM, DMX pass-thru
Housing:	Colour black, Steel
Size:	483 x 145 x 44.4mm
N.W.:	1.7 kg
Environment:	IP20

## ARTNET DMX AD8

### 8 way Ethernet-to-DMX splitter

#### Technical Data

Power supply:	110-240 V AC, 50/60 Hz
Power connection:	PowerCON in
Power consumption:	15W
DMX512 inputs:	2 x 3-pin XLR male
DMX512 outputs	8 x 3-pin XLR female
Ethernet:	2 x RJ45 100 Mbps
Protocol:	Art-Net 4
Housing:	Colour black, Steel
Size:	483 x 169 x 44.4mm
N.W.:	2.9 kg
Environment:	IP20



An ISO 9001:2015 Co.



## Our trademarks:

**Hotion** **Ovation** **iFROG**

## Guangzhou Hotion Technology Co., Ltd

Hotion innovation park, 108 Qixing gang road,  
Jiahe wanggang, Baiyun District, GuangZhou,  
China(510440)

T: +86 020 37411095

E: info@ovationlight.com

www.ovationlight.com | www.hotion.net

## Manufacture of:

- Studio Lighting
- Professional Lighting
- Entertainment Lighting
- Architectural Lighting



Download latest catalog

## Follow us on:



Instagram  
@ovationlight



Twitter  
@ovationlight



Facebook  
@ovationlighting



Youtube

© Copyright by Hotion 04/2019. All rights reserved.

All specifications are subject to change without prior notice

rev19\_04\_30